

版本 REV.	位置 LOC.	变更号 ECN NO.	变更内容 REVISION RECORD	日期 DATE	设计 BY
	△				
	△				
	△				

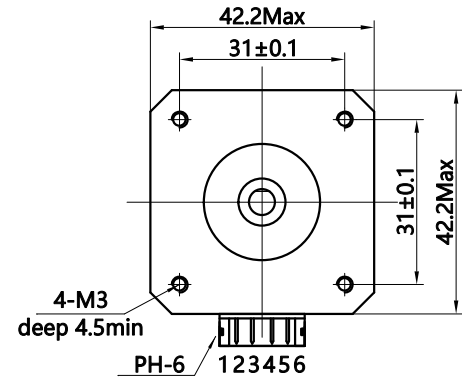

电机接线图

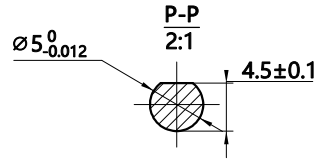
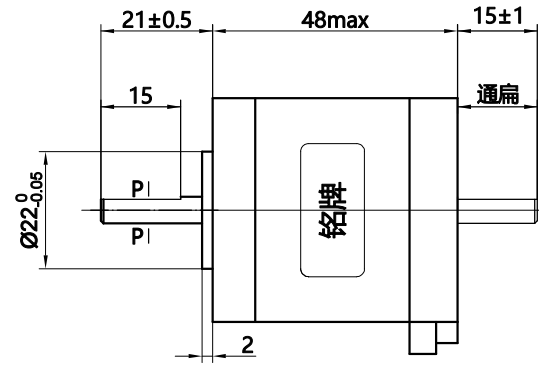
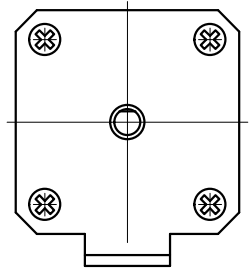
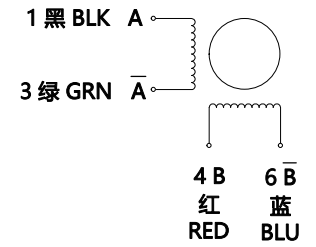

励磁顺序VS旋转方向
从电机的安装面看

STEP	A	B	A	B	
1	+	+	-	-	CCW ↑
2	-	+	+	-	
3	-	-	+	+	
4	+	-	-	+	

贴铭牌内容

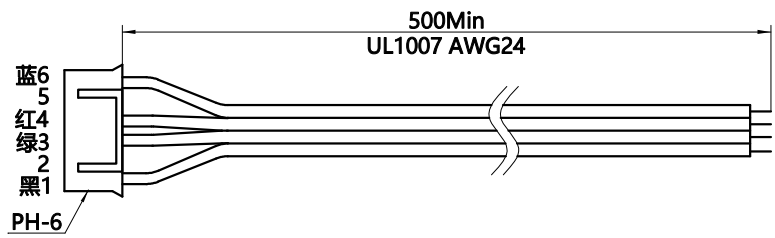
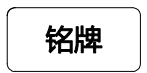

1.相数	Phase	2
2.步距角	Step Angle	1.8 ±5% °/Step
3.静电压	Voltage	3.36 VDC
4.额定电流	Current	1.68 A
5.电阻	Resistance	2.0 ±10%Ω
6.电感	Inductance	3.8 ±20% mH
7.静转矩	Holding Torque	5.2 Kg·cm
8.表面处理	Surface Treatment	端盖、定子黑色电泳
9.绝缘耐压	Dielectric Strength	500VAC/5mA/1min
10.绝缘电阻	Insulation Resistance	≥100MΩ/500VDC
11.绝缘等级	Insulation Class	Class B
12.线规	Lead Style	UL1007 AWG24
13.重量	Weight	TBD KG

1. 轴为借用
42HS48-B05-D210140 (扁丝 L15-14)

CTQ Sign: △ Customer; △ Process; △ Law		<p>常州市金三士机电有限公司 Changzhoushi Jinsan Shi Mechatronics Co.,Ltd</p>			
物料符合RoHS指令要求 All Material are to be RoHS Compliant					
UNLESS OTHERWISE SPECIFIED		名称 NAMES	签名 SIGNATURE	日期 DATE	名称 TITLE
单位 Unit:mm 1.未注线性公差参照 GB/T1804-m级 ISO 2768-1 class m <=6 ±0.1 >6~30 ±0.2 >30~120 ±0.3 >120~400 ±0.5		设计 DESIGN	NYJ	24.03.06	外形图
2.常规公差 Tolerances 角度 Angles:±0.1° 倒角 Chamfer:±5°		审核 CHECK			型号 MODEL 42HS48-1684JB05-D2115
第一视角画法 FRIST ANGLE METHOD		批准 APPROVE			图号 DWG.NO. DJ-000003473
变更标识 ECN SIGN		客户型号 CUSTOMER'S MODEL.NO.			材料 MATERIAL JSS14.1.42HS48.08.108
		版本 REV.	图幅 SIZE	比例 SCALE	页 SHEET
		A1	A3	1:1	1 of 1

规格 Specifications

备注 Comment