

Digital DreamCNC co.,LTD.

DDCSV2.1



DDCSV2.1 Product Specification (English Version)



Content

Chapter One Introduction	1
1.1 Introduction of Product	1
1.2 Performance parameter of Product	1
1.3 Outward Appearance, Structure and Size of Product	2
1.4 Explanation of Nouns	5
1.5 Notes and Warnings	6
Chapter Two Definition of Wiring	7
2.1 Definition and Method of Product Wiring	8
Chapter Three Software Operation and Parameter Settings	24
3.1 Interface description	24
3.2 Definition of Keys	29
3.3 Operation methods of common function	31
3.4 Parameter setting	70
3.5 Software upgrade	80
Chapter Four GCode and M Code	86
4.1 GCode Set	86
4.2 MCode Set	87
Chapter Five Contact and Feedback	88
5.1 Question and answer	88
5.2 Contact	89

Chapter One Introduction

1.1 Introduction of Product

The DigitalDream CNC has engaged in the numerical control industry for 7 years, specializing in the research, development and production work of various CNC(Computer Numerical Control)systems with high quality, high reliability. It can produce the common Brushless DC motor, Stepper motor driver as well as the 1 axisCNC system to 6 axesCNC system.

The DDCSV2.1 is the 4 axis and 4 axes motion controller which has been researched and developed by Faster CNC for four years. The control period of each position is only 4 milliseconds, with a high control precision. The highest uniaxial output pulse is 500KHz and the pulse width can be adjusted. It supports the common stepper motor and servo motor.

The DDCSV2.1 numerical control system adopts the ARM+FPGA design framework. The ARM can finish the part of human-computer interface and code analysis and the FPGA can finish the part of underlying algorithm and control pulse generate, with the reasonable design, reliable control and easy operation.

The panel layout structure of DDCSV2.1 is rational. The common off-line operation can be finished only by 17 keys and it supports the FANUC with high universality to be compatible with G code set.

This specificationintroduces the operation method of caving machine's special off-line CNC system, DDCSV2.1 and the machine tool connection as well as operation specification. By lots of graphical representation and examples, the uses can quickly learn to use the DDCSV2.1 CNC system.

DDCSV2.1 has made the following changes on the basis of DDCSV1.1:

- 1: The input signal is modified to support the NPN switch;**
- 2: Support limit and the home share the input port;**
- 3: Use the more stable FLASH, to ensure that no program loss;**
- 4: Upgrade algorithm, support soft interpolation, modified V1.1 version of arc interpolation bug;**
- 5: Upgrade the power module, the system is more stable.**

1.2 Performance parameter of Product

- 💧 Ordinary digital input interface of 16-circuit optocoupler coupling isolation
- 💧 Ordinary digital input interface of 3-circuit optocoupler coupling isolation

- Output interface of 0-10V spindle control port with analog quantity(can be modified as PWM output);
- Support the 4 axis stepper motor control, the highest control pulse output of single axis is 500KHz;
- ARM9 main control chip;
- FPGA core algorithm chip;
- 4.3 inches TFT screen, resolution ratio: 480*272;
- 17 operational keys;
- The main control equipment is 18V-32V power input, the current capacity is required not to be lower than 0.5A;
- Support the USB flash disk to read the G code,and the size of G codefile has no requirement;
- Be equipped with MPG port and support digital display MPG as well as support the general MPG in the market.
- Support the panel key with single-axis manual operation, manual step and CONToperation;
- Support the operation of quickly specify the running position;
- Support the multi coordinate systems (with automatically saving function in case of power cut);
- Support the function of saving data automatically after power down (press the start to automatically save the data in the operation, automatically save the data after power down)

1.3 Outward Appearance, Structure and Size of Product

- The DDCSV2.1 adopts the embedded shell structure, which can punch a square hole on the equipment cabinet and then embed this equipment in the square hole. Use two locking mechanism from the inside can fix this equipment on the equipment cabinet, with easy installation. The dimension figure of the product's outward appearance are as picture 1-1 and picture 1-2.

The panel size of the product is 163mm*102mm*5mm;

The size of main body is 156mm*93mm*45mm;

The size of square hole installed on the equipment cabinet is 156mm*93mm。

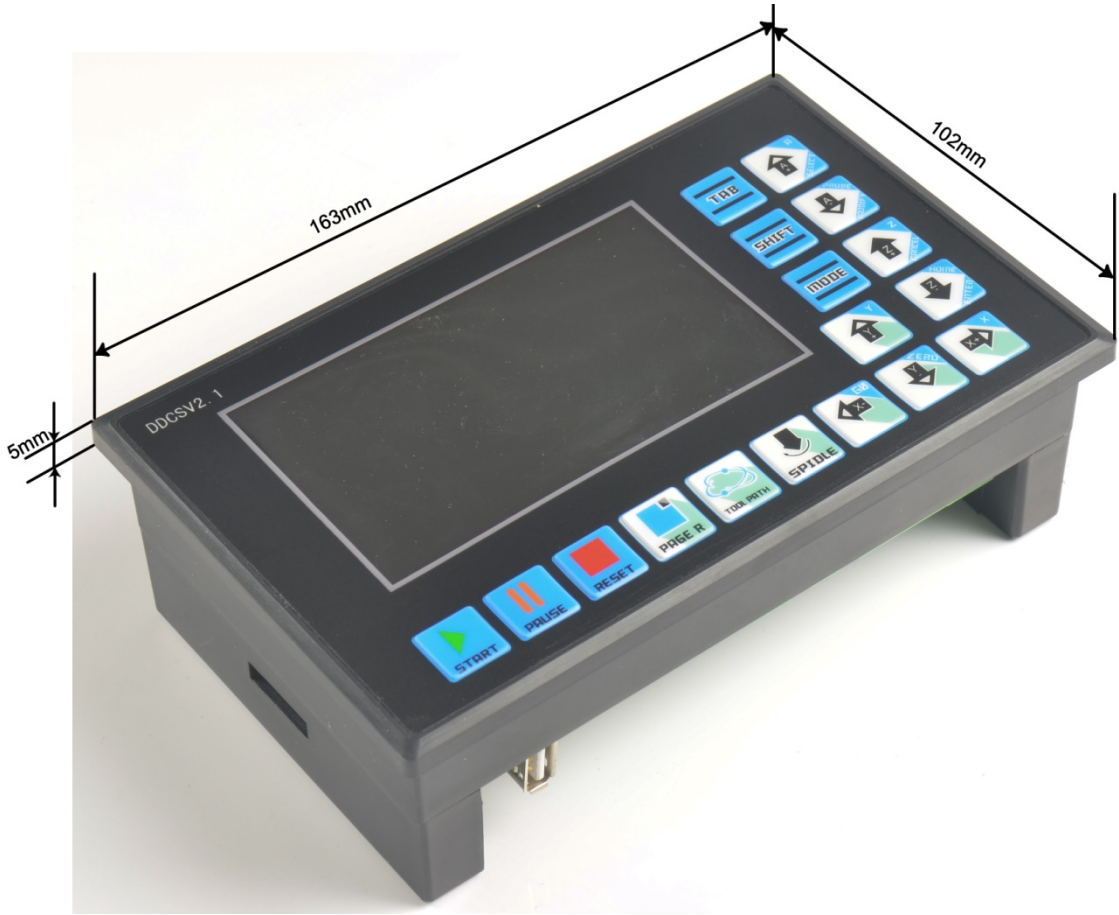

Picture1-1 DDCSV2.1Front external view and dimension figure

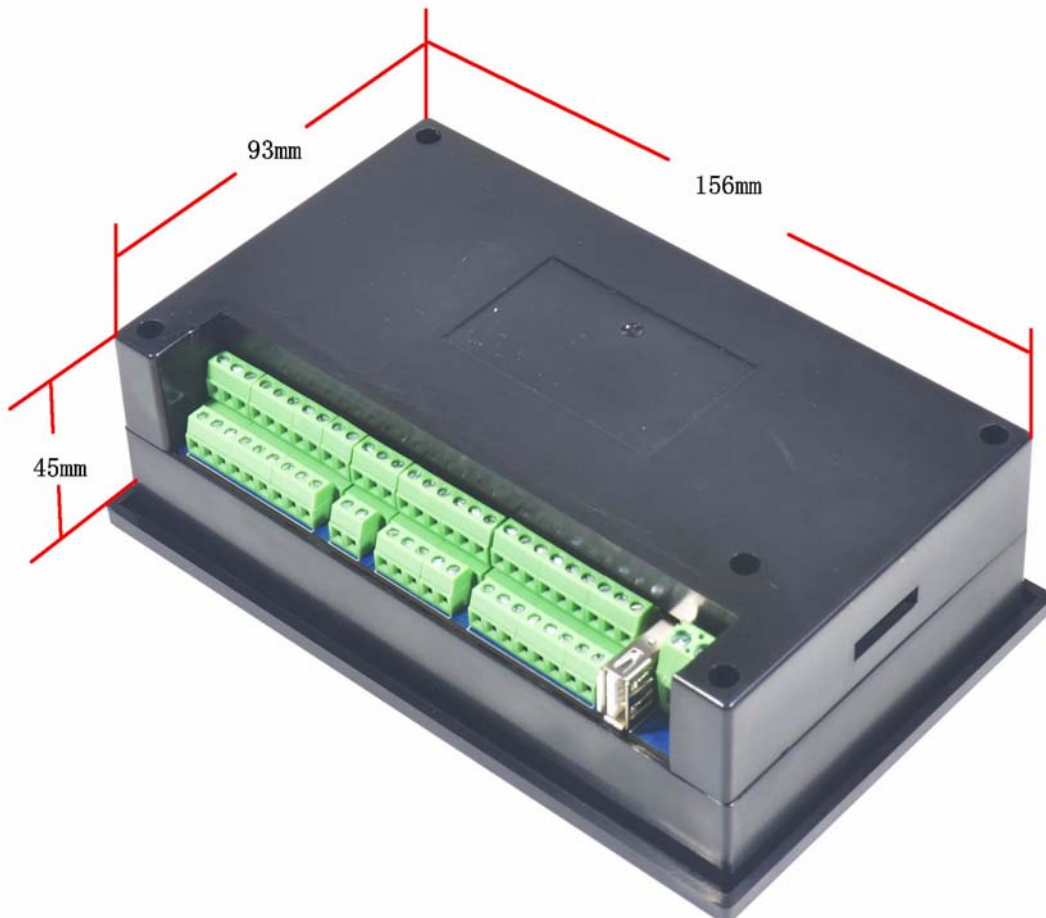

Picture 1-2 DDCSV2.1External view of the reverse side and dimension figure

The front of the product is 17 user keys and 1 4.3” and 480*272 LSD (Liquid Crystal

Display), and the reverse side is input signal, spindle control, stepper/ servo control, MPG and other four sets of interfaces as well as USB interface and power interface. Please look at the reference picture 1-3 and picture 1-4 in detail.

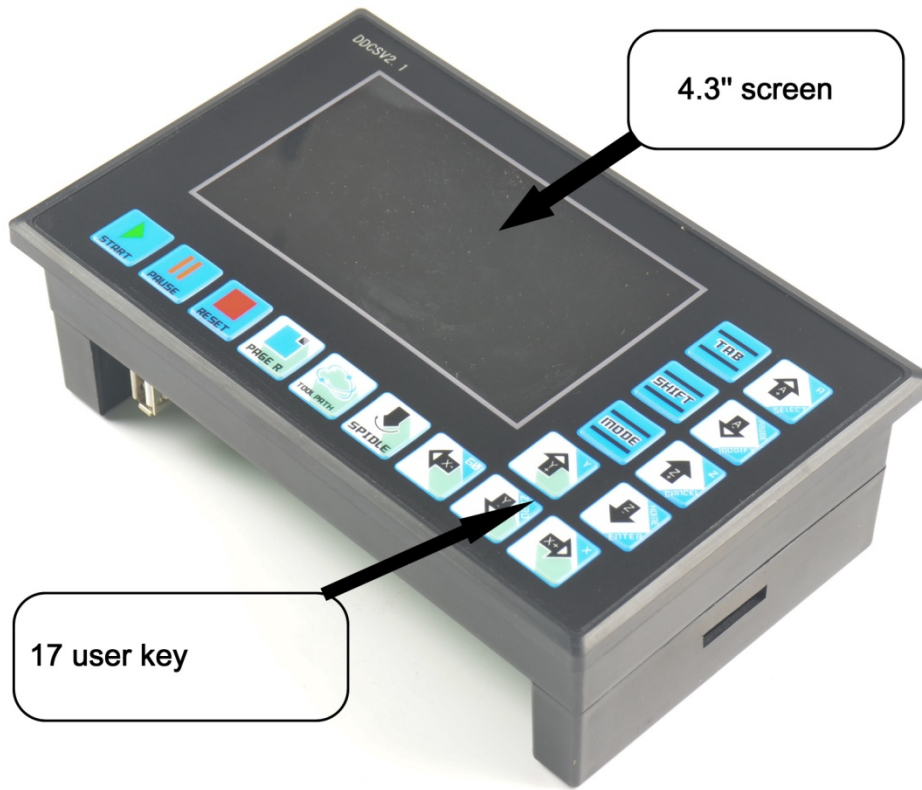

Picture1-3 Structure of front panel

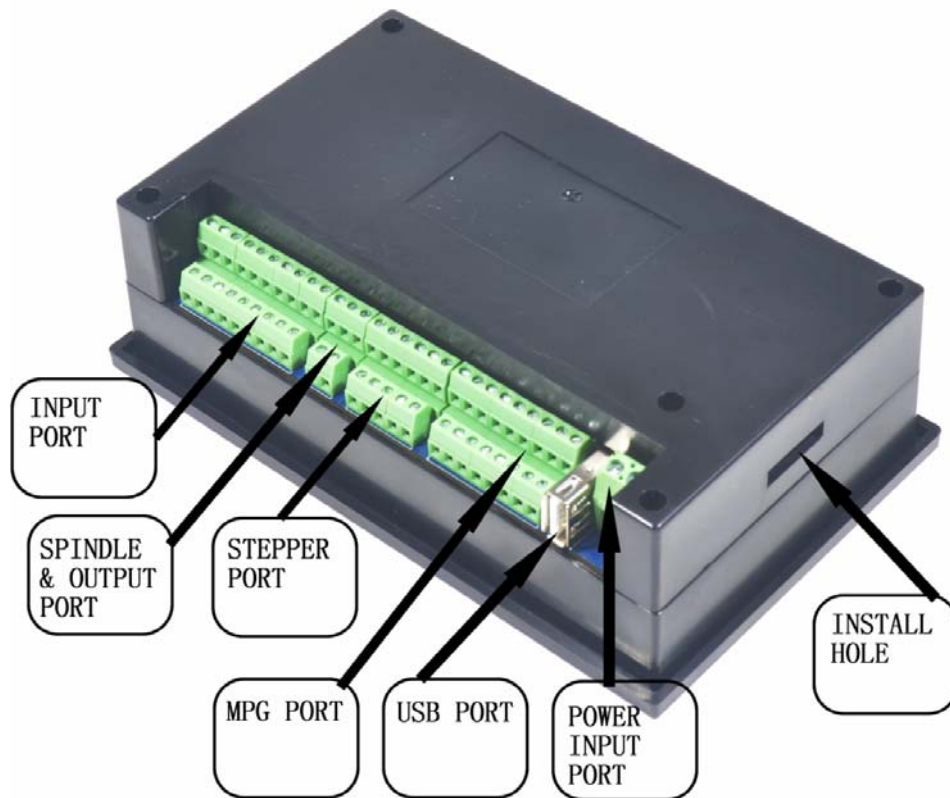

Picture1-4Structure of rear cover

1.4 Explanation of Nouns

When operating the DDCSV2.1, the users will come across some English abbreviation. Now all the abbreviations are listed to users for references.

FRO: the FRO mainly refers to adjust the FRO value to amend the current feed rate under the situation that the F value has been confirmed before the processing course or in the processing course. The actual rate $F\# = \text{setting rate } F * FRO$.

SRO: the SROrate mainly refers to adjust the SROrate to amend the current speed of spindle under the situation that the S value has been confirmed before the processing course or in the processing course. The actual speed of spindle $S\# = \text{setting rate } S * SRO$.

SRJ: SRJ, under the situation that the default value of manual operation rate has been set, it is impossible to set the value again to amend the manual operation rate when it is required to adjust the manual operation speed and CONT operation speed. At this moment, the SRJ value can be modified to realize the purpose of amending the manual operation speed. The actual speed of manual operation $FS\# = \text{setting manual operation speed } SRJ*$.

F: Feed rate, the unit is mm/min. For example $F=2000$, indicates that it can feed 2000mm per minute;

S: speed of spindle, the unit is rad/min. For example $S=20000$, indicates that it can rotate 20000 per minute;

X: The coordinate code of X axis.

Y: The coordinate code of Y axis.

Z: The coordinate code of Z axis.

A: The coordinate code of A axis

Busy: Server busy, it cannot conduct the processing operation, and parts of the function are open. For example, amend the FRO and value of SRO.

REDAY: REDAY mode, any operation can be done at this time, including the processing or modifying the parameter or starting the 2nd mode

Reset: reset mode, all the operations are forbidden to do at this time.

“CONT”: continuous operation, each axis can conduct the CONT operation under this mode.

“Step” :Manual step mode, each axis can conduct the manual step operation under this mode

MPG: MPGMode, each axis can conduct the MPG operation under this mode

AUTO: Automatic processing mode, it will show AUTO when enters the state of automatic processing.

1.5 Notes and Warnings



Free from exposure to the rain and avoid the moist. This product is the sophisticated electronics without waterproof function. Please keep it from the rain. Make the working environment as dry as possible. This is the icon.



Wiring warning, the IO input terminal of this equipment support the equipment with source switch (such as Inductive proximity switch). When using such kind of switch, attention please: avoid the +terminal and –terminal of power supply to connect with GND. This equipment’s analogy quantity output terminal of spindlecontrol alos have a certain load capacity. Please avoid this terminal connect with GND, in case that the interior components and parts be brokendown.



Operation warning, Please do the security measures well when connecting with the machine ools. The ESTOP, limit and other things must be perfected. When comes across the emergancy, please press the ESTOP key at once or cut off the power directly, thus avoiding the equipment damage and casualty.



High voltage danger, the primary device is 18-32V power supply. Voltageequipment;please pay attention to the electricity safety when conducting the operation.

Chapter Two Definition of Wiring

2.1 Power supply solution of equipment

In general, the power supply solution of industrial control's equipment products is complex. It has many different ground levels. Now the internal power supply structure of this product is described as follows:

The power supply structure of this product is as the picture 2-1. The Master Power Supply input and MPG module and stepper control module have the same ground. Limits ESTOP and other input modules as well the spindle speed control output /M3/M8/M10 and other output modules have the same ground, which are used the electric isolation among them. The limits ESTOP and other input modules are connected with the same positive. The internal of the equipment provides a 12V as the common + port, without the requirement of the external power source. As for the spindle rate port, take the output ground for references and output a 0-10V adjustable voltage as the use of spindle speed adjust. The M3/M8/M10 digital output port is the open drain signal. If it is required to externally connect a relay, it is necessary to take the output ground for reference, thus providing the external power supply for the relay.

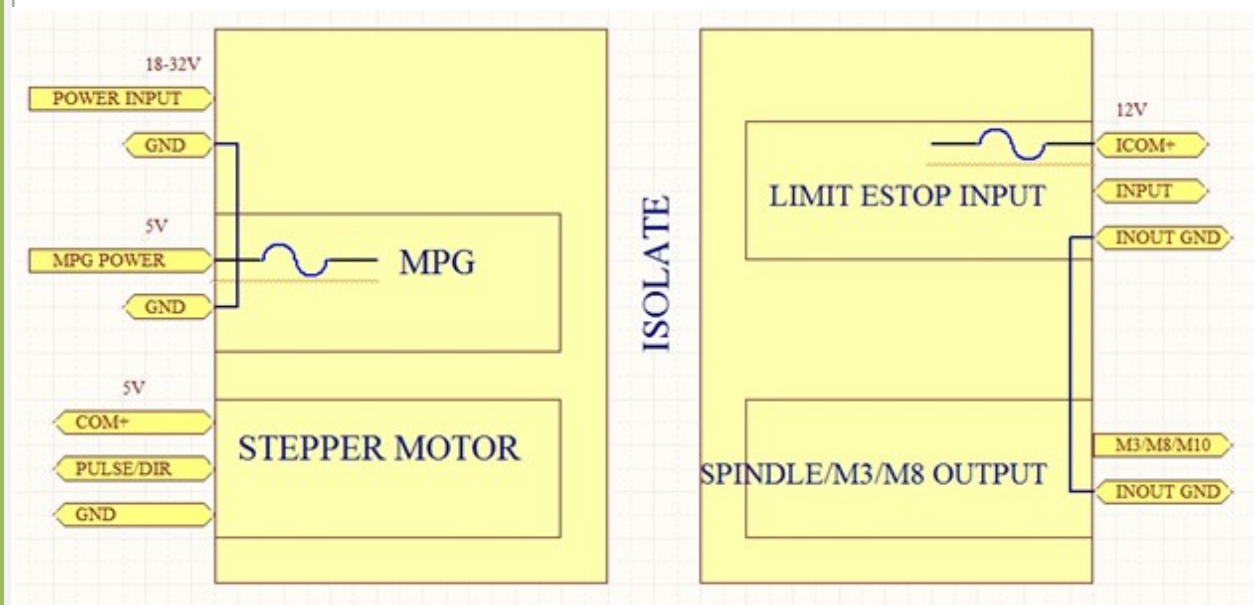

Picture 2-1. Power supply structure

2.2 Definition and Method of Product Wiring

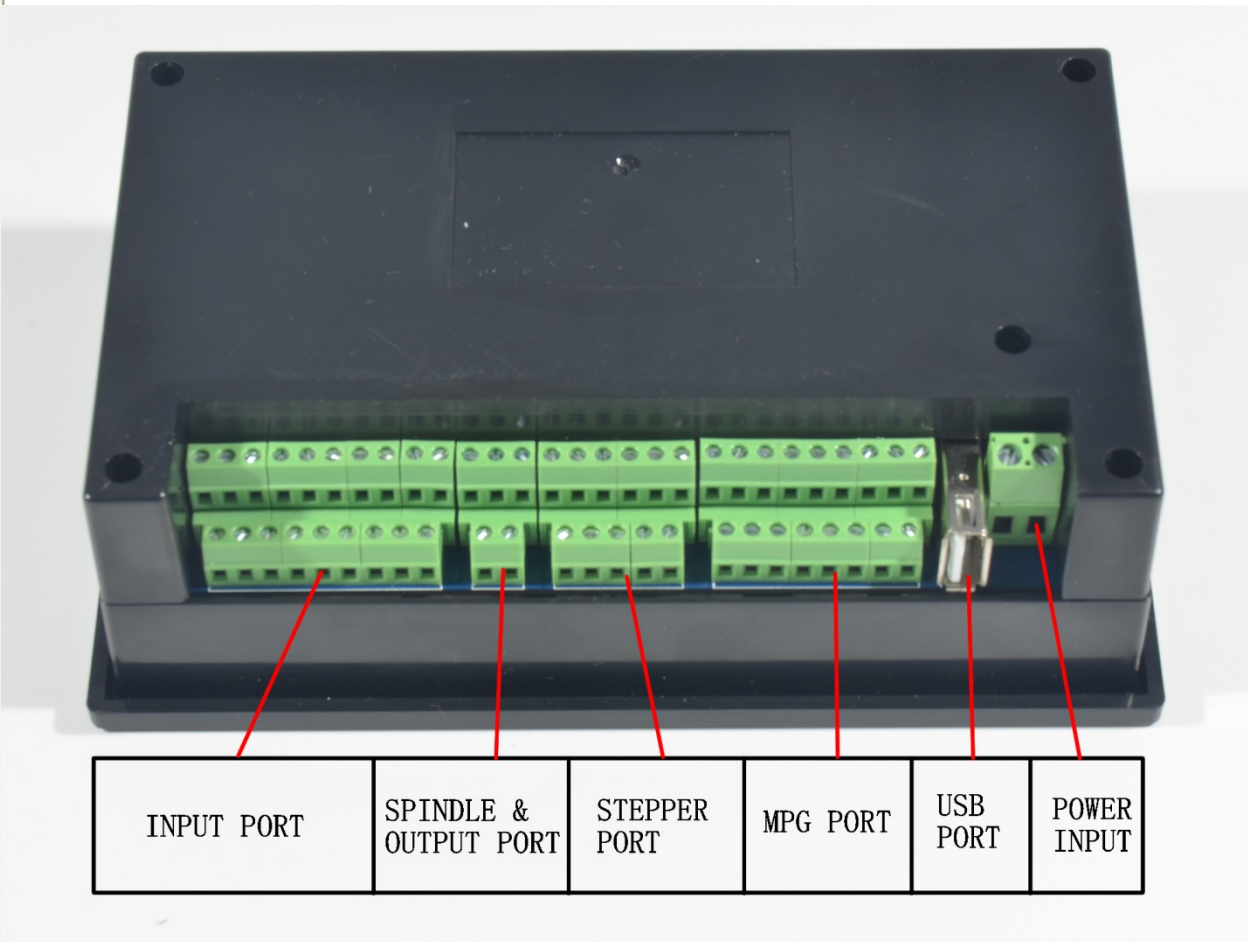

Picture 2-2. Product wiring section and interface summary

As the picture shows, the wiring section of this controller totally has power interface, USB interface, MPG port, stepper/servo control output interface, spindle control output interface, ESTOP limitprobe and other input interface as well as 6 interfaces with different functions. Now the detailed situations about these 6 functional interfaces are described as follow.

2.2.1 Power Interface

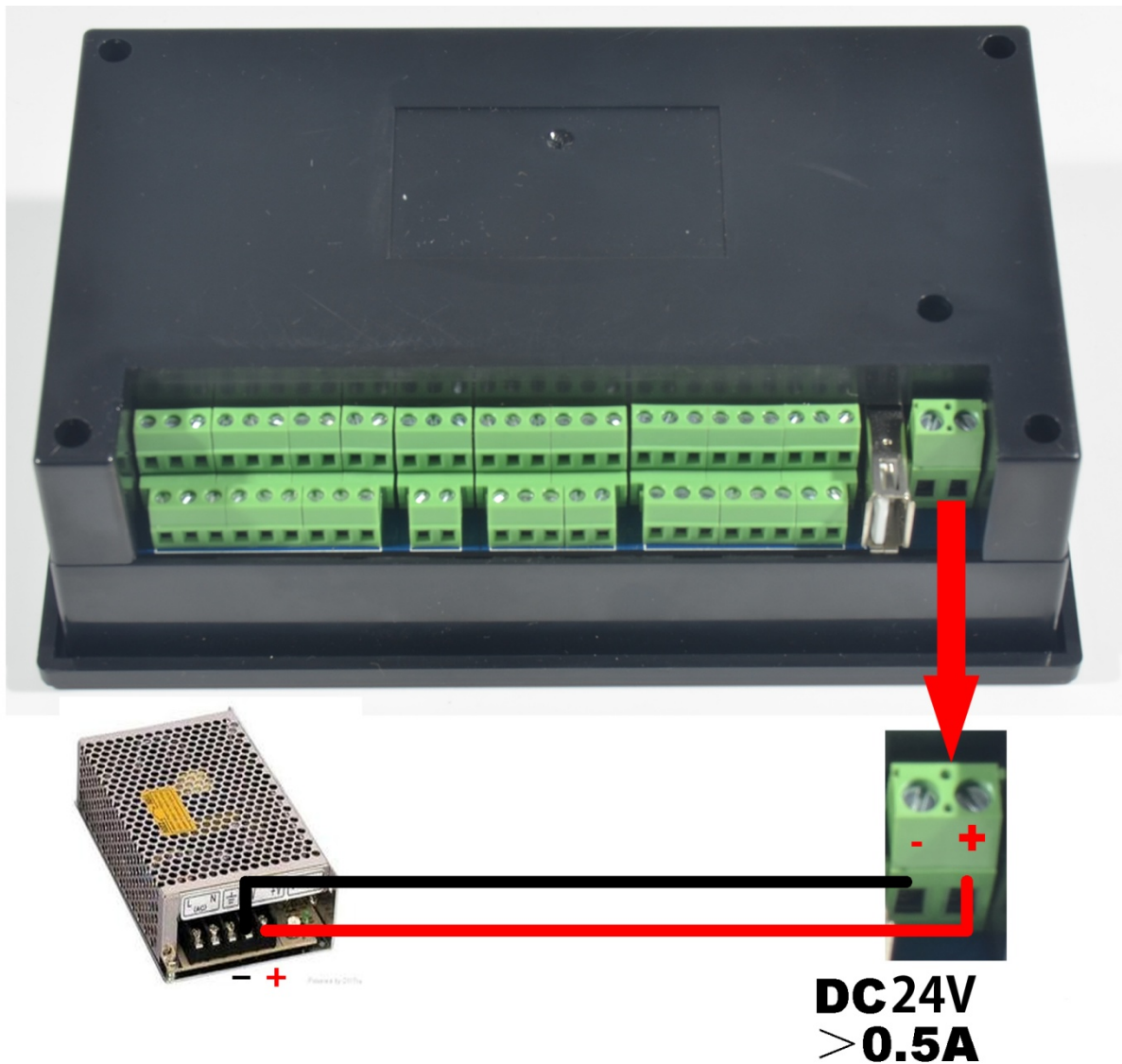

Picture 2-3. Main power input interface definition diagram

As the Picture 2-3 shows, the power interface is 5.08mm wiring terminal. As the picture shows, the right wiring terminal is the positive power, and the left wiring terminal is the negative power, accepting the power supply of $18V-32V \pm 0.5V$ with direct-current supply. **Strongly recommended to use 24V switching power supply.** The current capacity is required to be more than 0.5A.

2.2.2 USB Interface

This USB Interface is the standard USB socket of A-type, attached a 50cm USB extension cord with installation lugs. The sketch diagram for reference is the picture 2-4.

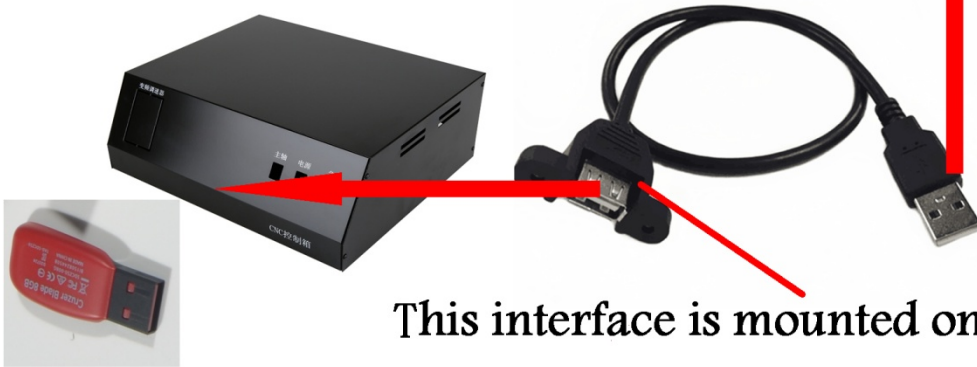
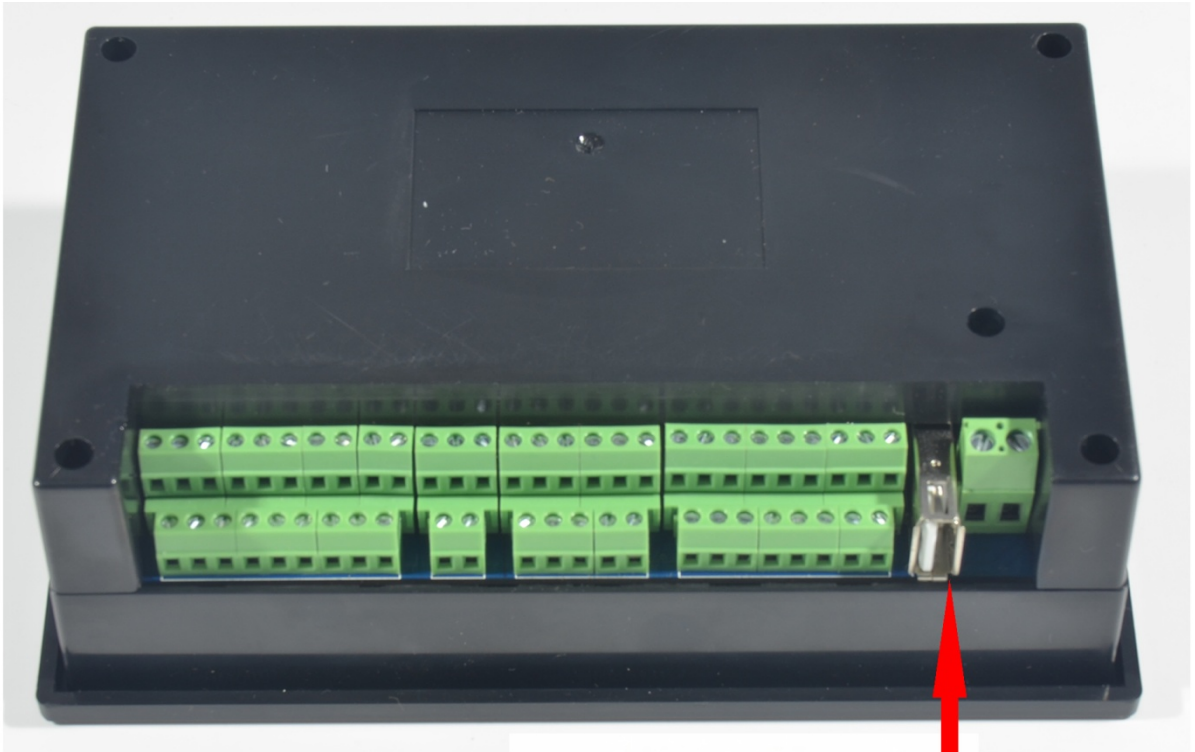

This interface is mounted on the panel

Picture 2-4. Sketch diagram of USB interface extension cord USB

2.2.3 MPG Port

The MPG port picture is showed as the Picture 2-5. From the reverse side of the product, it is the 8+9 double row interface which is close to the USB interface. The reference of interface definition is Picture 2-6.

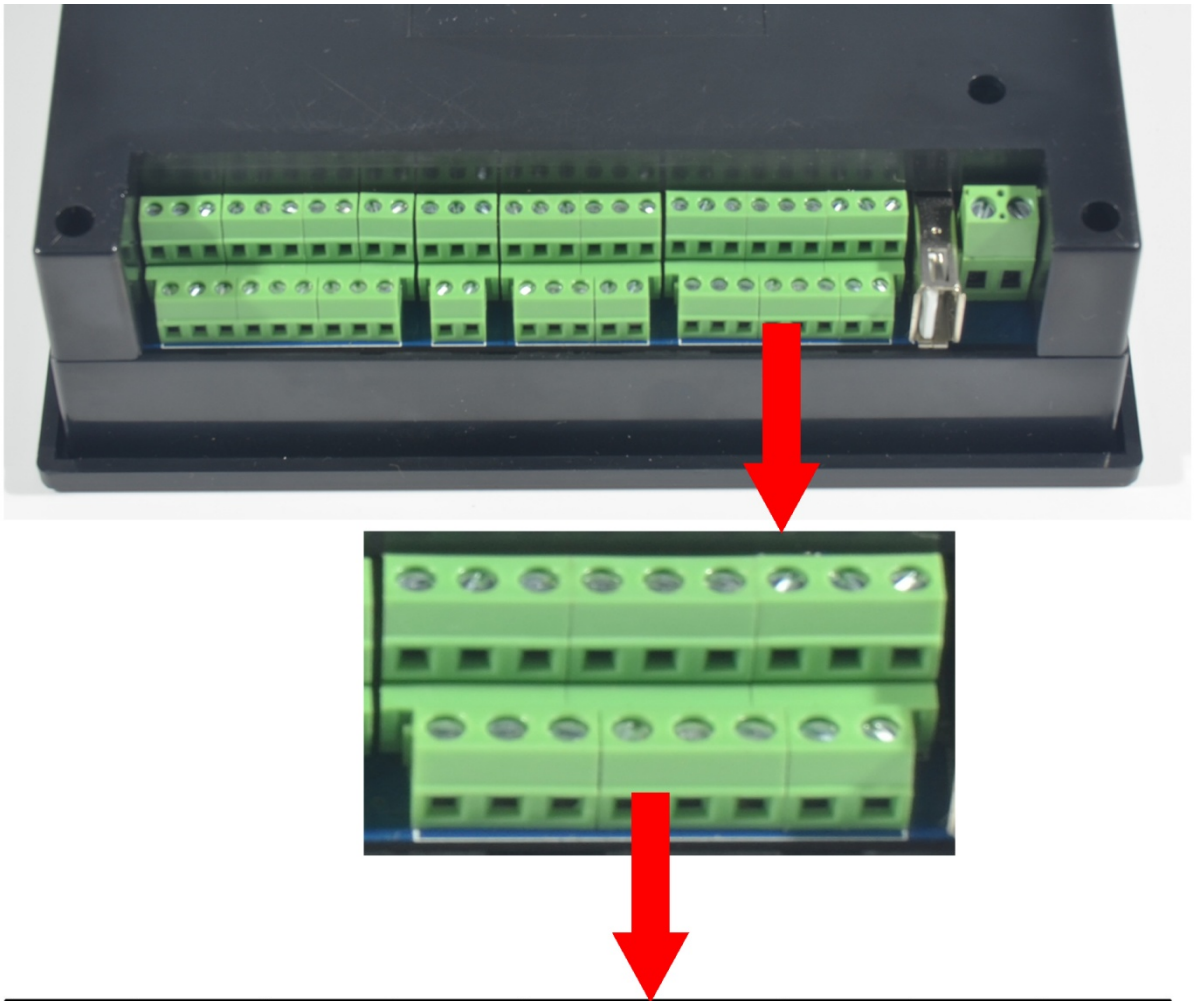

ESTOP	x1	x10	x100	GND	WHB-	WHA-	+5V-W	RXD
X-IN	Y-IN	Z-IN	A-IN	WHB+	WHA+	GND	TXD	

Picture 2-5. Products picture of MPG port

ESTOP	x1	x10	x100	GND	WHB-	WHA-	+5V-W	RXD
X-IN	Y-IN	Z-IN	A-IN	WHB+	WHA+	GND	TXD	

Picture 2-6. MPG port definition diagram

As the picture 2-6 shows, the MPG port totally have 17 wiring terminals, and the reference of each wiring terminal definition is table 2-1. The reference of corresponding relation between system and MPG wiring is table 2-2 and table 2-3.

Pin mark	Definition	Notes
ESTOP	ESTOP of MPG	Connect with GND, indicates the ESTOP is in effect, open indicates it is invalid.
X 1	Select switch with 1 X	Connect with GND, indicates selecting 1 X, open indicates no pulse.
X10	Select switch with 10 X	Connect with GND, indicates selecting 10 X, open indicates no pulse.
X 100	Select switch with 100 X	Connect with GND, indicates selecting 100 X, open indicates no pulse.
Ground	MPG ground	MPG power supply reference ground, so it is the switch signal reference ground.
B phase-	MPG B phase negative terminal	MPG B phase differential input negative terminal
A phase-	MPG A phase negative terminal	MPG A phase differential input negative terminal
+5V-W	MPG power supply 5V power output	Exclusive use supply terminal of MPG, which can restore the fuse connection with a 200MA of the system power supply.
RXD	MPG serial communication input terminal	Used for digital display of the MPG communication
X select	Select switch in X axis	Connect with GND, indicates selecting X axis, open indicates not to select
Y select	Select switch in Y axis	Connect with GND, indicates selecting Y axis, open indicates not to select
Z select	Select switch in Z axis	Connect with GND, indicates selecting Z axis, open indicates not to select.
A select	Select switch in A axis	Connect with GND, indicates selecting A axis, open indicates not to select.
B phase+	MPG B phase positive terminal	MPG B differential input positive terminal
A phase+	MPG A phase positive terminal	MPG A phase differential input positive terminal
ground	MPG ground	MPG power supply reference ground, so it is the switch signal reference ground
TXD	MPG serial communication output terminal	Used for digital display of the MPG communication

Table 2-1 Definition and interpretation of DDCSV2.1's MPG port



		
DDCSV2.1 Wiring pin mark	MPG pin mark and color	
ESTOP	C	Light blue
X1	X1	Grey
X10	X10	Black/Grey
X100	X100	Orange
X Select	X	Yellow
Y Select	Y	Black/Yellow
Z select	Z	Brown
A select	4	Black/Brown
A phase+	A+	Green
A Phase-	A-	Purple
B phase+	B+	White
B Phase-	B-	Purple/Black
Ground	0V/CN/COM	Black; Black/ light blue; Black/Orange
+5V-W	+5V	Red

Table 2-2 Differential MPG and DDCSV2.1 wiring mode

Note: It you want to use the single-terminal MPG (namely there is no A-B-MPG), please look at the wiring table, the table 3-2 for reference. As for the unlisted one, please take the differential MPG wiring mode.

DDCSV2.1 Wiring pin mark	MPG pin mark and color	
A phase+	A+	Green
A phase-	0V	Black

B phase+	B+	White
B phase-	0V	Black

Table 2-3 Single-terminal MPG and DDCSV2.1 wiring mode

2.2.4 Stepper/Servo control output interface

As the picture 2-7 shows, the second group of interface from the right side is the stepper/servo control output interface. The reference diagram of interface definition diagram is table 2-8. As for the connection between system and stepper motor drive, please look at picture2-9 for reference.

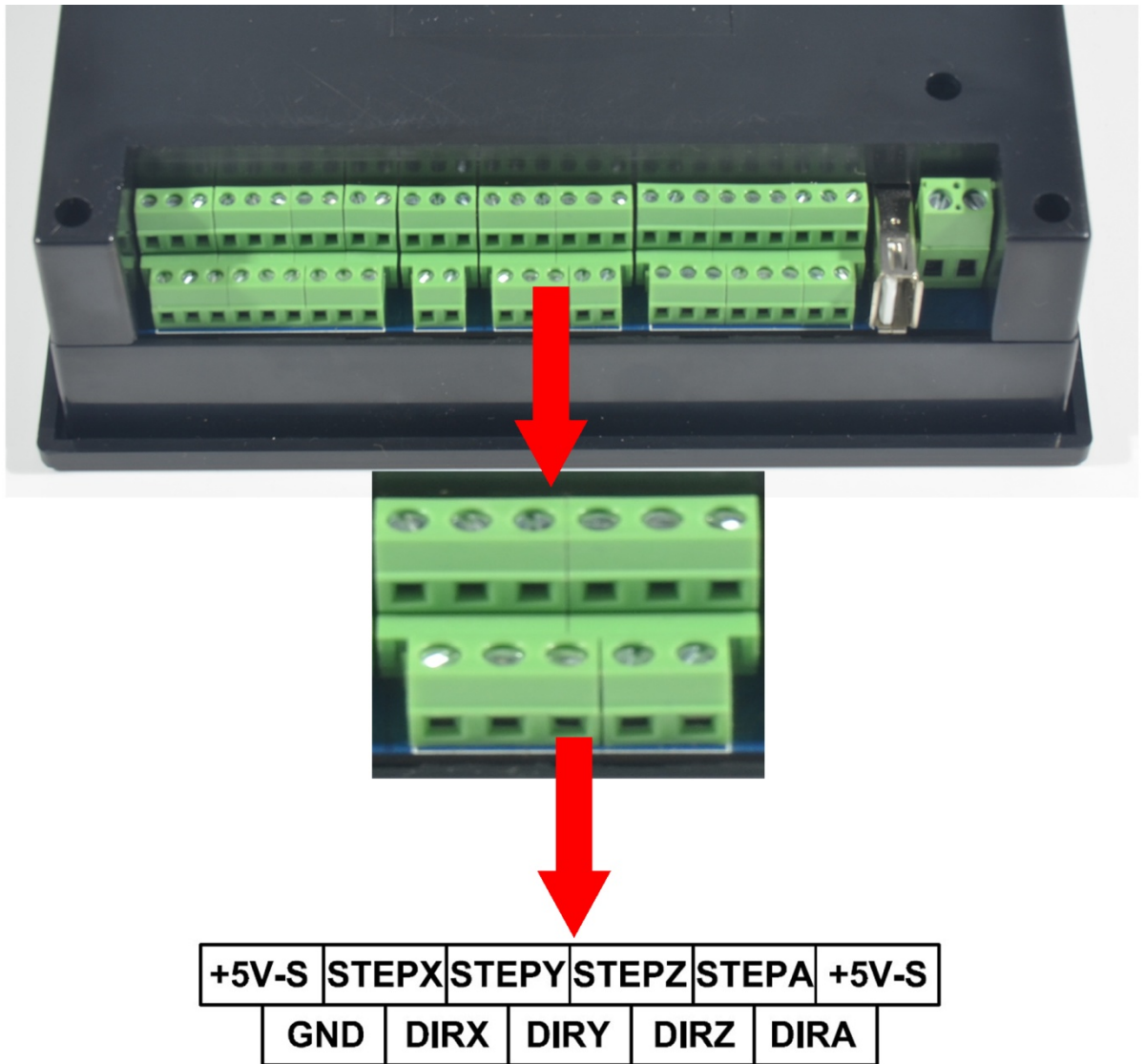

Picture 2-7. Product photo of stepper/servo control output wiring



Picture 2-8. stepper/servo control output interface definition picture

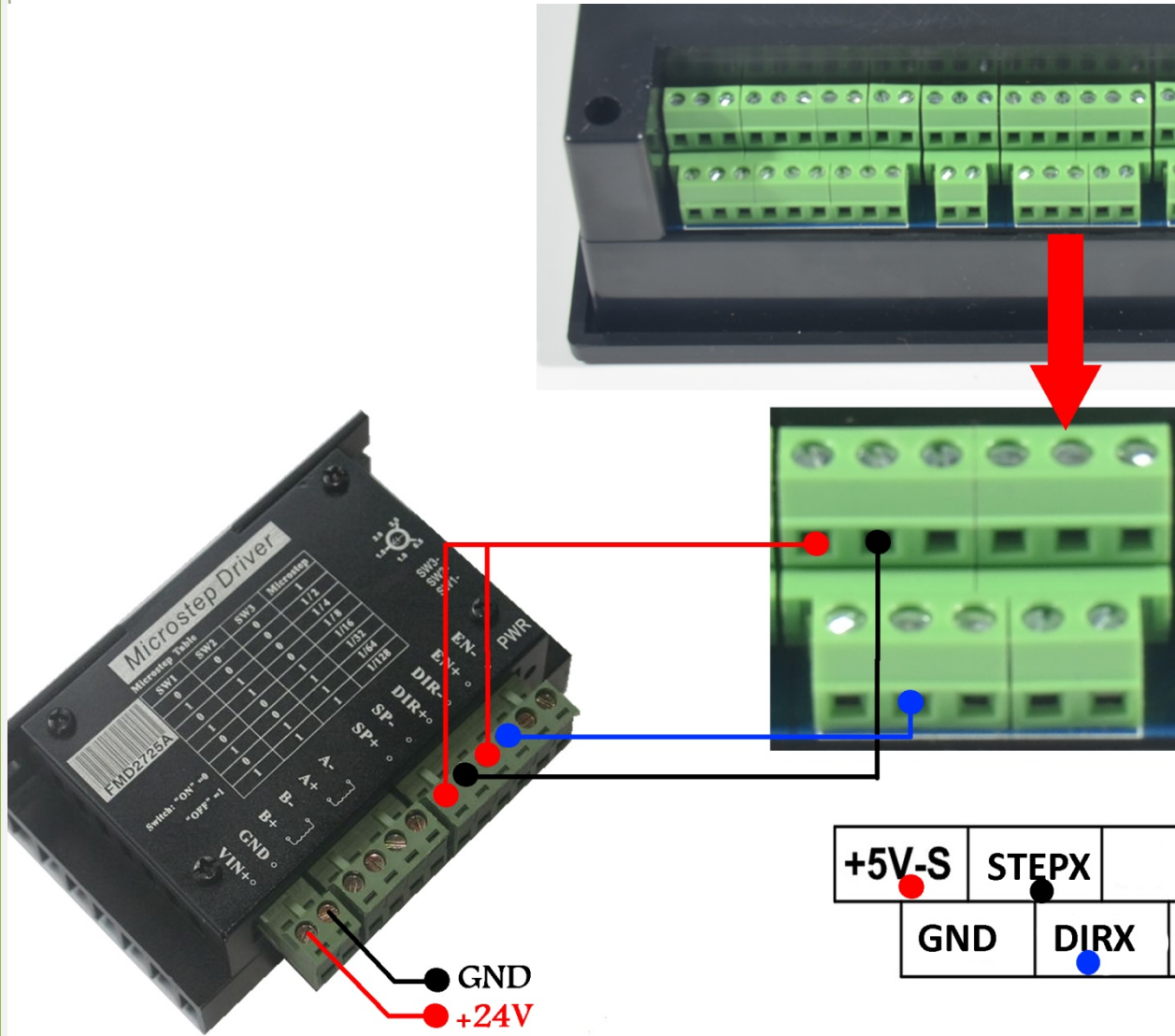

Picture 2-9. DDCSV2.1 X axis and stepper motor driver wiring picture

Stepper/servo control interface wiring definition reference table 2-4

Pin mark	definition	Note(common-positive wiring method)	Note (Common-negative wiring method)
+5V-S	5Vpower supply positive terminal	Common positive terminal	Not used
Ground	ground	Not used	Common ground terminal

Note: Strictly prohibit to directly connect +5V-S with the GND			
Pulse X	X axis pulse	X axis pulse signal negative terminal	X axis pulse signal positive terminal
Direction X	X axis direction	X axis direction signal negative terminal	X axis direction signal positive terminal
Pulse Y	Y axis pules	Y axis pulse signal negative terminal	Y axis pulse signal positive terminal
Direction Y	Y axis direction	Y axis direction signal negative terminal	Y axis direction signal positive terminal
Pulse Z	Z axis pulse	Z axis pulse signal negative terminal	Z axis pulse signal positive terminal
Direction Z	Z axis direction	Z axis direction signal negative terminal	Z axis direction signal positive terminal
Pulse A	A axis pulse	A axis pulse signal negative terminal	A axis pulse signal positive terminal
Direction A	A axis direction	A axis direction signal negative terminal	A axis direction signal positive terminal

Table 2-4DDCSV2.1's stepper/servo control interface definition and interpretation

2.2.5 Spindle control output interface

As the picture 2-10 shows, the interface of third group from the right side is the spindle control output interface. As for the interface definition diagram, please look at picture 2-11 for reference.

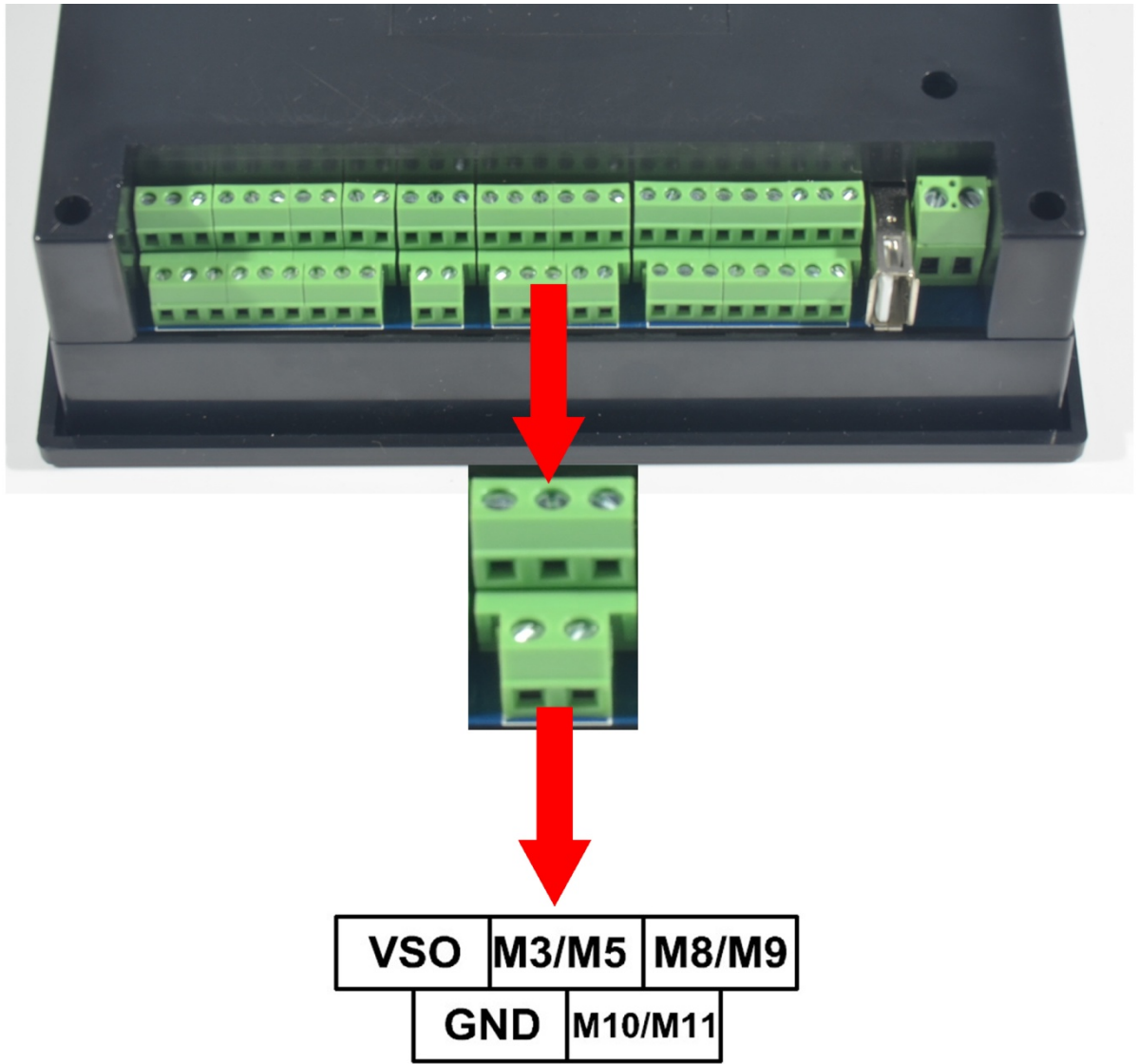

Picture 2-10. Product photo of spindle control output interface

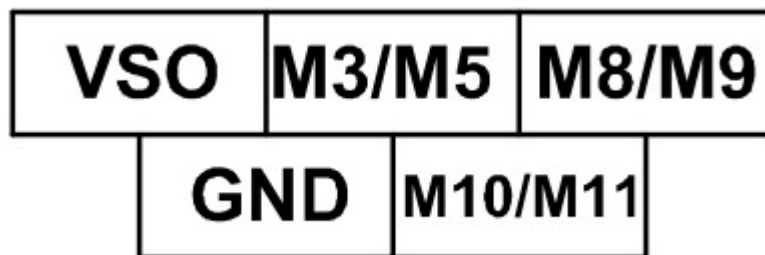

Picture 2-11. Spindle control output interface definition picture

In the spindle control output interface, the start and stop of spindle (M3/M5), cooling liquid (M8/M9), lubricating oil (M10/M11)'s three output terminals are totally the signal of open ground. The highest electric current can be absorbed is 20mA, and the reference diagram of interior structure is picture 2-12. The speeding governing output terminal can output 0-10V adjustable voltage. It can adjust the speed of spindle motor by adjusting the F value of spindle and outputting to the frequency converter.

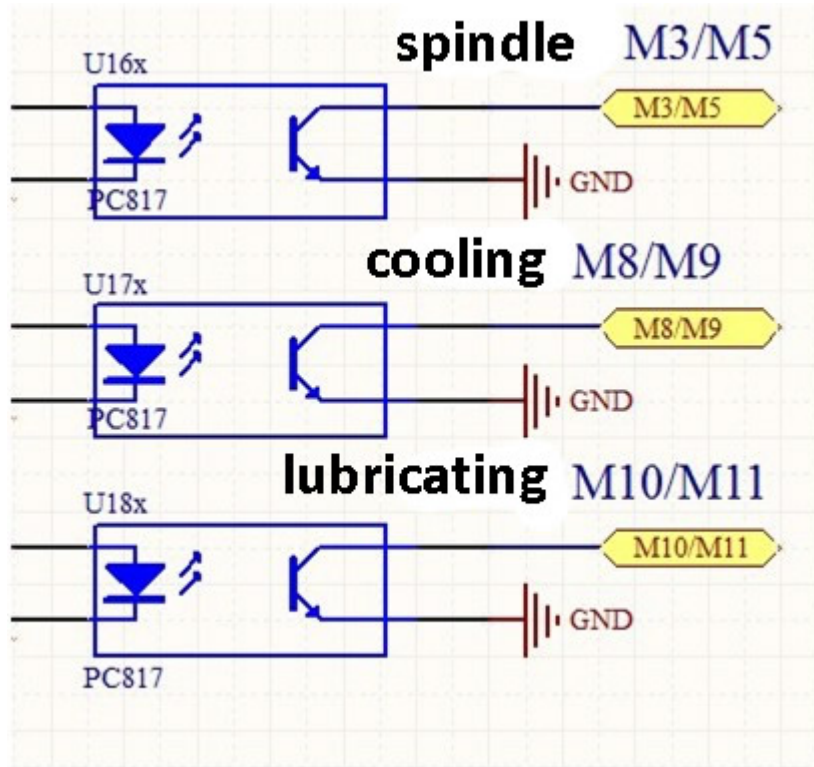

Picture 2-12. Interior structure picture of on-off output signal

Connection between DDCSV2.1 output and RELAY shows in picture 2-13.

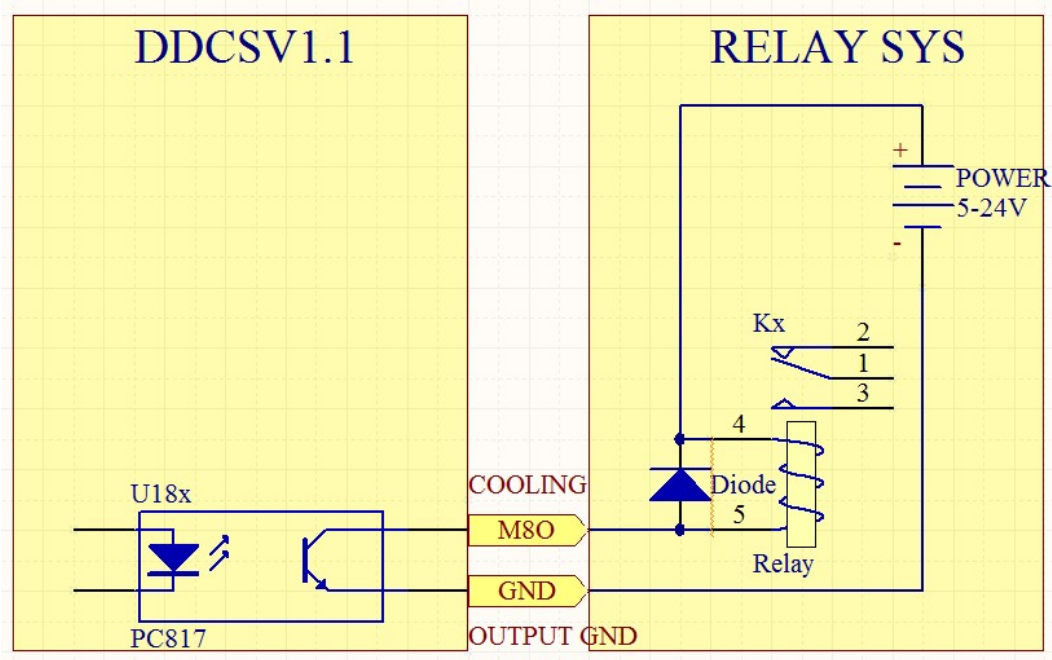

Picture 2-13. Connection between DDCSV2.1 output and RELAY system

Controlling the frequency conversion spindle only needs 2 signals and one is the start-stop control and the other is speed control. Here takes the Nowforever frequency converter as an example. As for the specific wiring, please look at table 2-5 for reference. The wiring of other frequency converter is also like this.

	
DDCSV2.1 wiring pin mark	Nowforever E100S1R5B wiring terminal mark
Speeding governing output (0-10V)	VI
Start and stop of spindle (open ground)	FOR
Output ground	DCM
Output ground	ACMNote: parts of frequency converterDCM and ACM are connected. Only one of them is needed at this time.

Table 2-5 DDCSV2.1 and frequency converter wiring mode

2.2.6 ESTOP limit probe input interface

As the picture 2-14 shows, the interface of group one from the lift side is the ESTOPprobeinput interface. As for the interface definition diagram, please look at Picture 2-15 for reference.

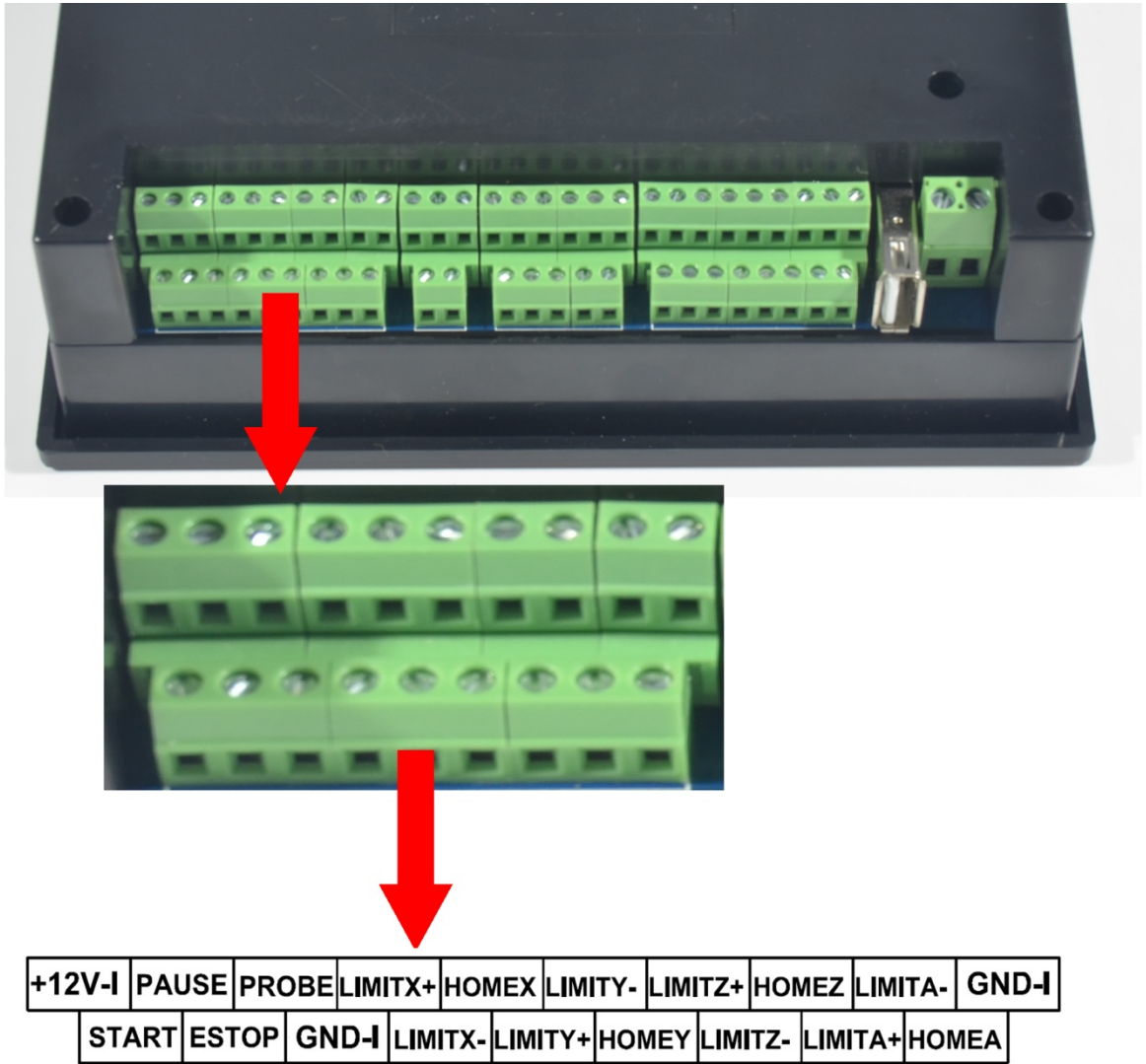

Picture 2-14. Product photo of ESTOP limit probe input interface

+12V-I	PAUSE	PROBE	LIMITX+	HOMEX	LIMITY-	LIMITZ+	HOMEZ	LIMITA-	GND-I
START	ESTOP	GND-I	LIMITX-	LIMITY+	HOMEY	LIMITZ-	LIMITA+	HOMEA	

Picture 2-15. ESTOP limit probe input definition picture

This interface contains three kinds of input signals, including the external-expansion start and stop, probe and limit/home. Circuit of input shows in picture 2-16. It's only a few of the input signals, the other are the same. Now the wiring modes of all kinds of signals are described as follows.

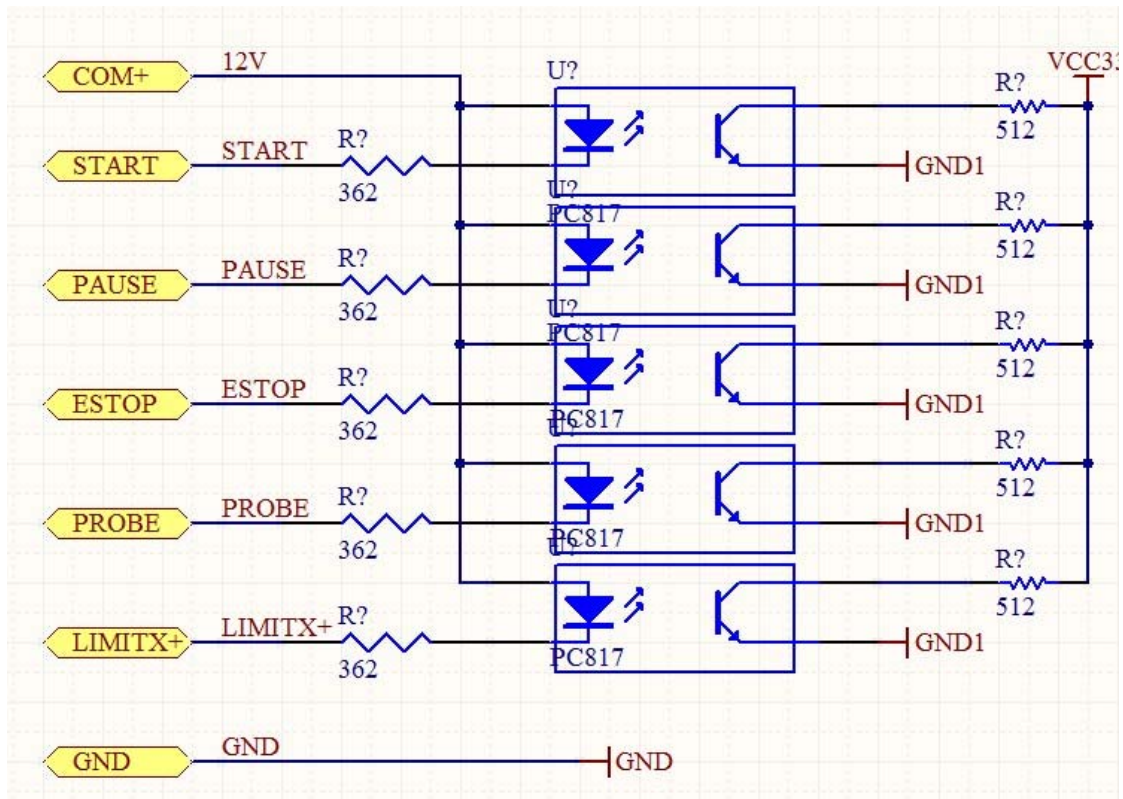

Picture 2-16. ESTOP LIMIT and PROBE input signal circuit.

The picture 2-17 is the wiring mode of external-expansion start, pause and ESTOP.

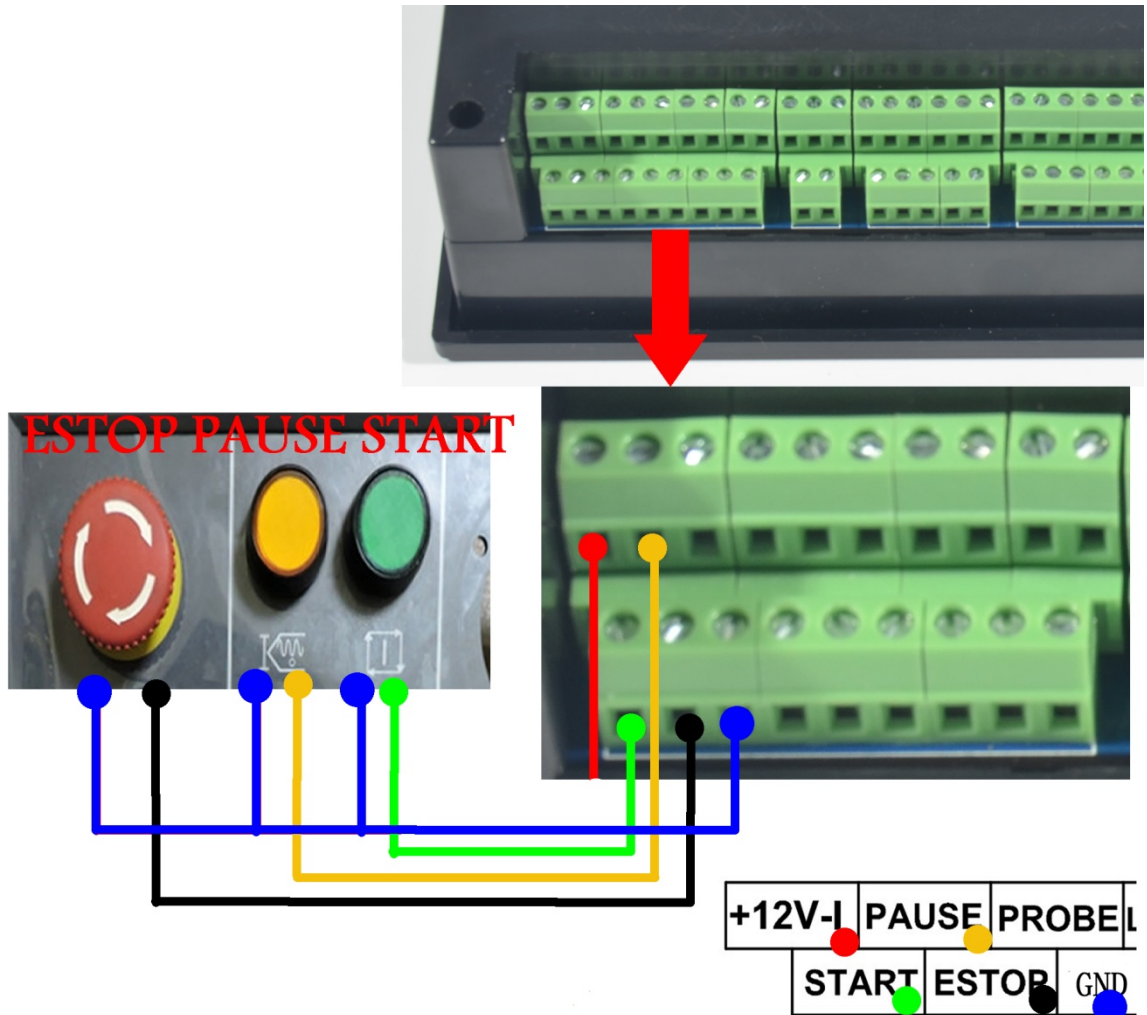

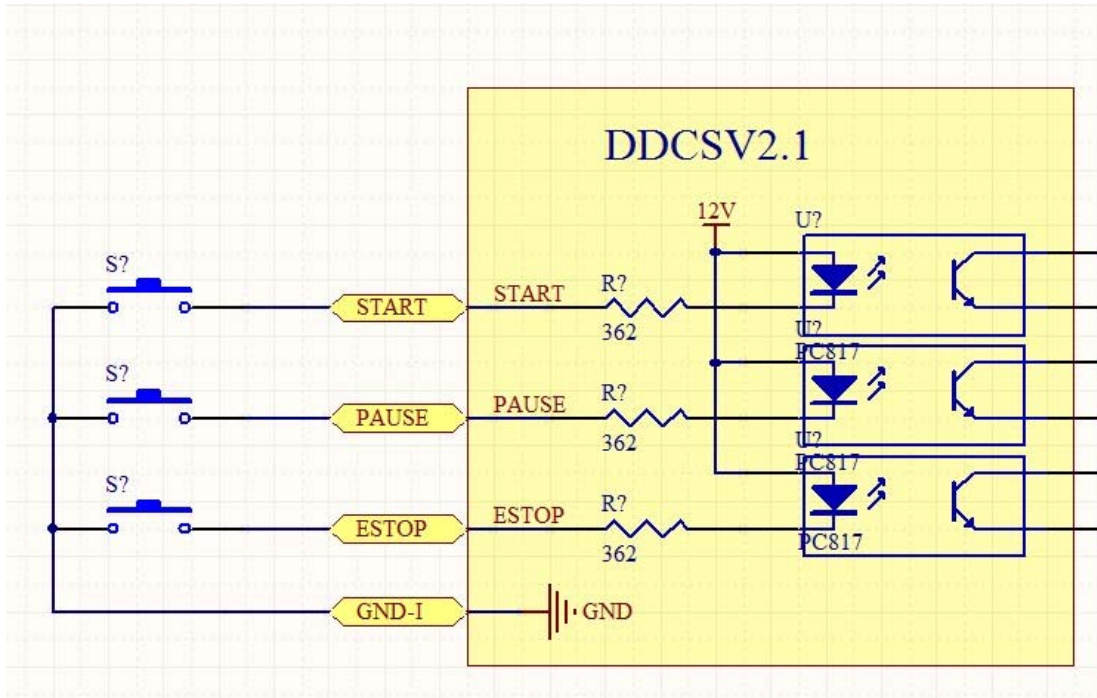

Picture 2-17. Wiring mode of external-expansion start, pause and ESTOP

The picture 2-18 is the wiring mode of general jogging/2-line Inductive proximity switch. The picture 2-19 is the wiring method of 3-line induction type switch. Pls use NPN type switch.

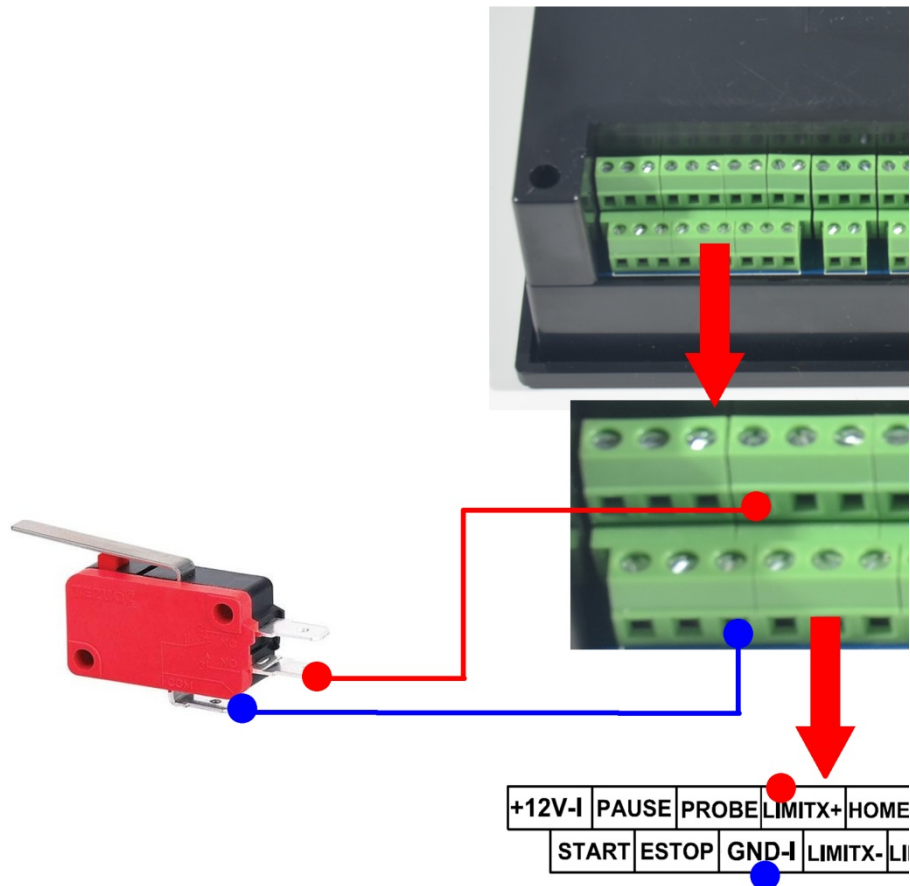

Picture 2-18. Limit/home general micro switch or wiring mode of 2-line Inductive proximity switch

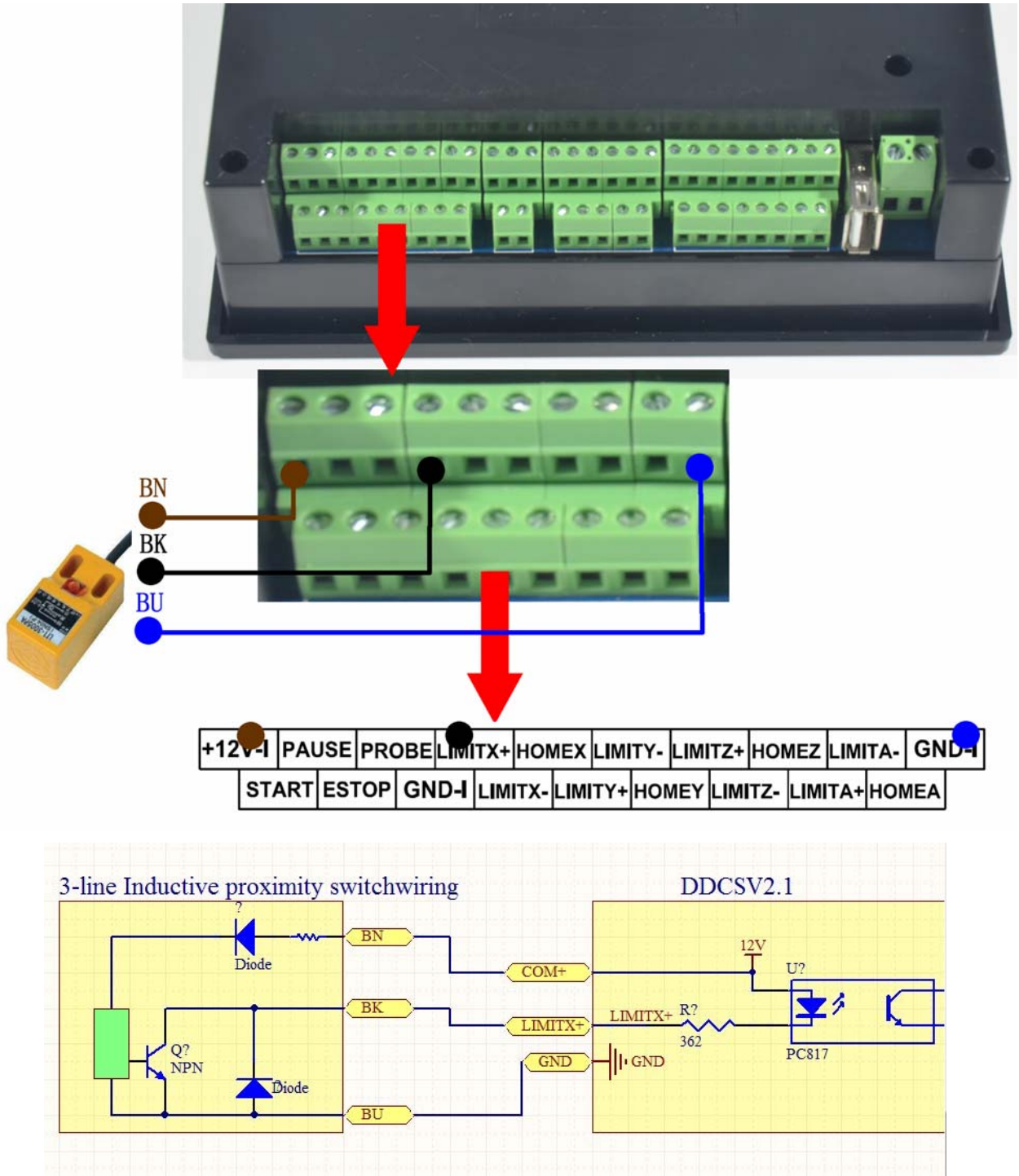

Picture 2-19. 3-line NPN Inductive proximity switchwiring mode

Chapter Three Software Operation and Parameter Settings

3.1 Interface description

The software interface totally contains 3 pages, including main page, file page and configuration page. Now the 3 pages are described as follows:

3.1.1 Main page

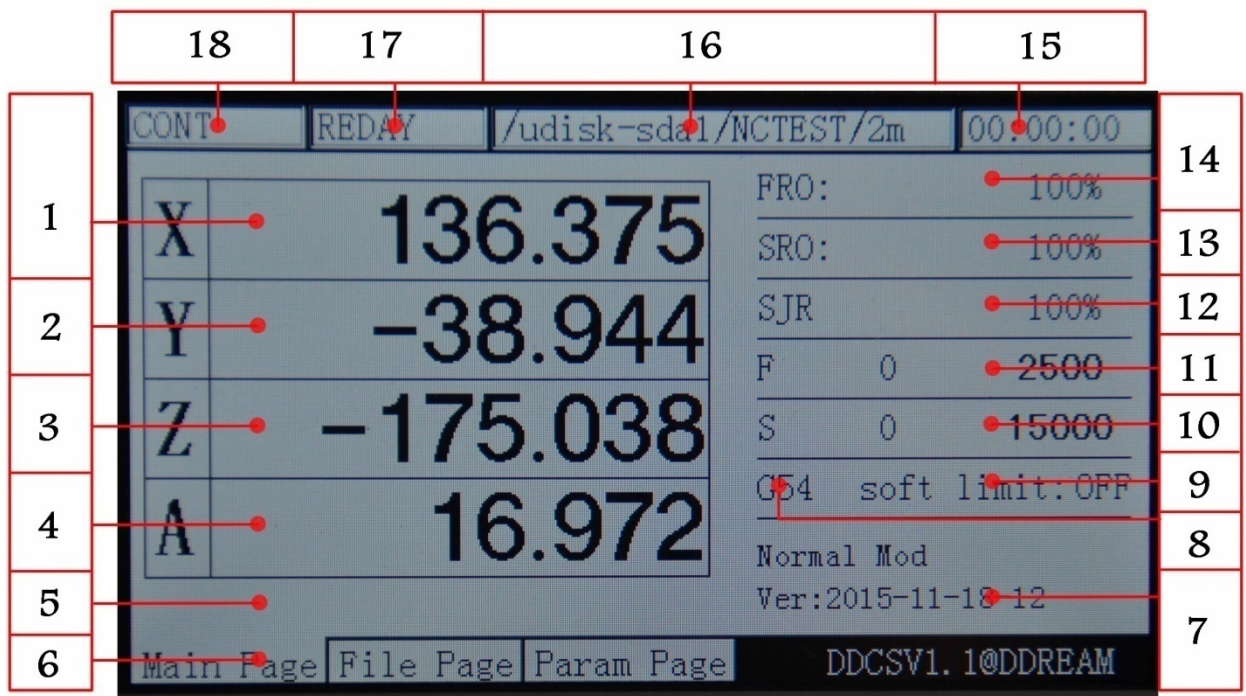

Picture3-1. Main page

The picture 3-1 shows the home page of DDCSV2.1. Altogether it is divided into status column, coordinate display column, basic parameter column, and notification column these four modules. In total, it is divided into 18 sections in detail. Now the detailed description of the 18 sections as follows:

1、X Coordinate

This column shows the current coordinate value of X work piece. The display range is -99999.999~+99999.999, the minimum jump value is 0.001.

2、Coordinate

This column shows the current coordinate value of Y work piece. The display range is -99999.999~+99999.999, the minimum jump value is 0.001.

3、Coordinate

This column shows the current coordinate value of Z work piece. The display range is -99999.999~+99999.999, the minimum jump value is 0.001.

4、 A Coordinate (This section has no definition in the 3-axis)

This column shows the current coordinate value of Z work piece. The display range is -99999.999~+99999.999, the minimum jump value is 0.001.

This section has no definition in the 3-axis

5、 Current operation

When this column performs the G codefile, it will show the current operation line number and codes. When the operation state is REDAY, it will show null.

6、 Page Code

The page code instructs the current page. This controller totally has 3 pages, including main page, file page and configuration page.

7、 Operation Tips

This prompt message only has 3 status switching. Mainly it provides the prompt message of several key buttons and the second functional operation function.

The prompt message of the normal state is: normal mode.

The prompt message of the second functional start status is:X-: gotoz Y-: zero Z-: home A-: probe Start: goto break

When the prompt message is in this status, knock on X-key to enter the goto zerofunction; knock on Y-to enter the current coordinate 0 clearing function; knock on Z-to enter the search machinery 0-point function; knock on A- to enter the probe function; knock on Start to enter the designated staring function; knock on Pause to enter the breakpoint CONT callback function.

When it is in the designated line editing or in the required editing digital, the prompt message is:X+: leftX-: Right Y+: Up Y-: Down Z-: enter Z+: cancel

When the prompt message is in this status, knock on X+ cursor to move left; knock on X- cursor to move right; knock on current place value to increase; knock on Y- current place value to decrease; knock on Z- to enter or carriage return; knock on Z+ to cancel;

8、 Current Coordinate System

It can use FRO/ SROand then press the key to switch to this column, thus amendingthe current coordinate system by A+/A-. The modification range is G54-G59.

When shifts to this column, the words of G54 will change as bold type.

9、 Soft limit switch

It can use FRO/ SROand then press the key to switch to this column. When it shifts to this column “soft limit”, the word “ON” will change to as bold type. At this time, please press



the key to select whether to shift to pen the soft limit.

10、 Speed of spindle

It can use the FRO/ SROand then the key switch to come to this column. When shifts to this column, the word of S will change as the bold type. The 0-position on the left will show the

real speed of spindle. The 0-position on the right will show the default speed of spindle. This default speed can be modified.

11、 Feed speed

It can use FRO/ SRO and then press the key to switch to this column. When it shifts to this column, the word of F will change as bold type. The place of 1182 on the left will show the real time feed rate, and the place of 2400 on the right will show the default feed rate. This default speed can be modified.

12、 SJR

It can use FRO/ SRO and then press the key to switch to this column. When it shifts to this column, the word of manual adjust will change as bold type. At this time, please press the key A+ to increase the manual adjust value, and press the key A- to decrease the manual adjust value. Each step will increase or decrease 10%.

13、 SRO

It can use FRO/ SRO and then press the key to switch to this column. When it shifts to this column, the word of spindle will change as bold type. At this time, please press the key A+ to increase the spindle adjust value and press A- to decrease the spindle adjust value. Each step will increase or decrease 10%.

14、 FRO/ SRO

It can use FRO/ SRO and then press the key to switch to this column. When it shifts to this column, the word of feed adjust will change as bold type. At this time, please press the key A+ to increase the feed adjust value and press A- to decrease the feed adjust value. Each step will increase or decrease 10%.

15、 Working time

This column shows the processing time from starting operating the G code timekeeping to the stop of proceeding ending time. It will also pause in the midway of pause time.

16、 Processing file

This column shows the processing files. In the formal situation, it only shows the filename. Under the situation of CONT adjust, it will also show the content of the file.

17、 Operating Status

This column shows the operating status of equipment. The status and implications can be displayed as follows:

Busy: In the process of processing status, manual operating single-axis status and other arbitrary axis status;

Reset: The reset flashing indicates to enter the reset status. At this time, any other keys don't work;

REDAY: Ready state; when it is in the state of reset, you can press the reset key to enter the REDAY status. At this time, it can operate and execute the automatic processing or modify other parameters and other operations.

18、 Feed status

This column shows the feed status of equipment. The status and implications can be displayed as follows:

Automatic: in the process of processing and executing the G code file status, and displaying AUTO;

CONT: indicates CONT. At this time, please press and hold the key“-”or “+” of XYZA, which can make each axis to CONT;

Step: indicates runs step by step. At this time, please knock on the key“-”or “+” of XYZA, which can make each axis to move 1-unit distance and this unit distance can be modified in manual adjust parameter. Although you hold these keys, you can only make each axis to operate 1-unit distance. This function can be used in accurate positioning;

MPG: indicates to enter the MPG mode. At this time, the MPG is invalid. The position of each axis can be operated by the MPG;

2nd mode: When you press this key, you can enter the second function status. At this time, the status line will display the second function.

3.1.2 File Management Page

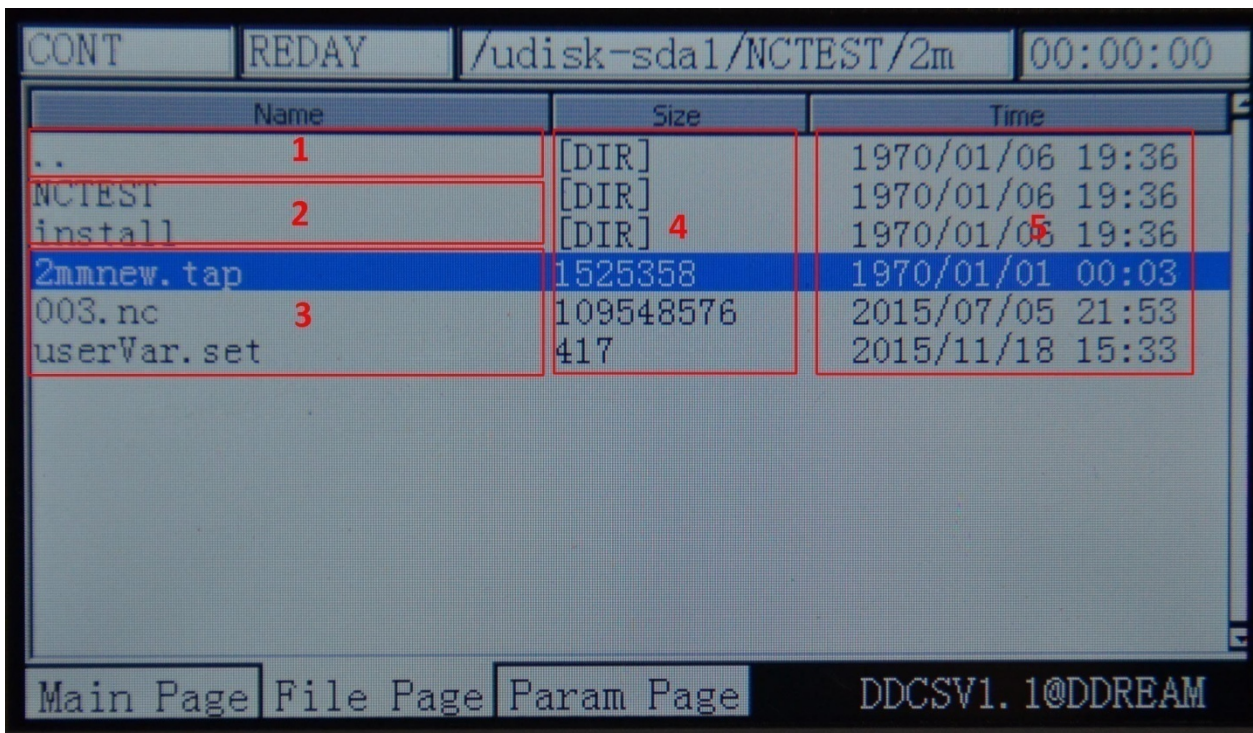

Picture3-2. File management page

As the picture3-2 shows, the file management page totally can be divided into 5 columns

1、 Switch of the content column

“..”Indicates to enter the file content of last level

2、 Subfolders list of current folder

The frame 2 displays all the subfolders list of current folder;

3、 File list of current folder

The frame 3 displays all the files list of current folder;

4、Files size column

The frame 4 displays the size of each file, and the unit is byte. If it is folder, it will display [DIR].

5、Column of files modification time

The frame 5 displays the modification time of each file or folder. The files or the folder status can be judged by the modification time.

3.1.2 Configuration Page

No.	Param Name	Value	Unit
[Setting of motor]			
33	speed of motor start running	50.000	mm/min
34	pulse equivalency of X axis	1280.000	pulse/mm
35	pulse equivalency of Y axis	1280.000	pulse/mm
36	pulse equivalency of Z axis	1280.000	pulse/mm
38	pulse equivalency of A axis	640.000	
39	pulse unit of A axis	pulse/degree	
390	level of X axis DIR signal	High	
391	level of Y axis DIR signal	Low	
392	level of Z axis DIR signal	High	
393	level of A axis DIR signal	Low	
416	time between DIR & pulse	300	ns
417	width of pulse signal(include	2000	ns

Picture3-3. Configuration page

As the picture 3-3 shows, the configuration page can be divided into 4 columns;

1、Parameter mark

Each parameter has a specific mark, the parameter can be modified by the way of configuration the files. Therefore the parameter can be designated by the parameter mark.

2、Parameter definition

The real definition of parameter is listed in the parameter definition column. Please note that all the parameters are divided into groups according to the function. The format of group title is [group], which is showed as the picture 3-3 [electrical machine configuration]

3、Parameter Value

The parameter value column lists the concrete value of each parameter. This value has integral, floating-point, BOOL switch and other types of data. As the picture 3-3 shows, the parameter value of No. 33 is 50.000, which is a floating-point data.





4、Parameter Unit







The parameter unit lists the unit of each parameter.

3.2D

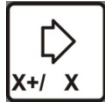
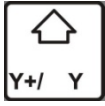

The picture 3-4 shows the keys layout of DDCSV2.1. The DDCSV2.1 totally has 17 keys. As for the specific definition of keys, please look at table 3-1 for reference.

Keys Icon	Function Number	Definition	Notes
	1	Start operation	After correctly loading the G code file, please press this key to start the automatic processing operation. Or at the status of pause, please press this key to recovery the processing operation.
	1	Pause operation	In the process of processing, please press this key to pause the operation.
	1	ESTOP reset	Under the status of reset ("reset "flashing), please press this key to enter the ready condition status; In the status of processing, please press this key to stop processing urgently.
	1	Page switch	Switch the file management page, processing main page and parameter configuration page.
	1	Tool path display switch	Switch the display into coordinate display or tool path tracking display.

	1	Spindle manual start/close	Under the status of ready condition (REDAY), please press this key to manually off/on the spindle. Under the reset status (reset) and processing status (busy), it cannot operate this function.
	3	1: X axis moves left; 2: Cursor moves left 3: Goto zero function	Under the status of ready condition(REDAY), when you switch the mode into “CONT”, the X axis will Continuously move left after pressing this key; When you switch to “step”, it will be the left manual step; when you enter status of the processing line editing or the default F/S value modification, this key has the function of cursor left movement; When you start the second function, this key has the goto zero function;
	3	1: X axis moves right; 2: Cursor moves right 3: X axis select	Under the status of ready condition(REDAY), when you switch the mode into “CONT”, the X axis will Continuously move right after pressing this key; When you switch to “step”, it will be the rightmanual step; when you enter the status of the processing line editing or the default F/S value modification, this key has the function of cursor right movement; Under the 3 functions of home/zero-clearing/ gotoz, this key has the X axis select function when you need to start the single-axis operation.
	3	1: Y axis moves forward; 2: Parameter value increases 3: Y axis select	Under the status of ready condition(REDAY), when you switch the mode into “CONT”, the Y axis will Continuously move forward after pressing this key; When you switch to “step”, it will be the forwardmanual step; when you enter the status of the processing line editing or the default F/S value modification, this key has the function of increasing the current value; Under the 3 functions of home/zero-clearing/ gotoz, this key has the Y axis select function when you need to start the single-axis operation.
	3	1: Y axis move backward; 2: Parameter value decreases; 3: Start the current coordinate 0-clearing	Under the status of ready condition(REDAY), when you switch the mode into “CONT”, the Y axis will Continuously move backward after pressing this key; When you switch to “step”, it will be the backwardmanual step; when you enter the status of the processing line editing or the default F/S value modification, this key has the function of decreasing the current value; When you start the second function, this key has the current coordinate 0-clearing function;
	3	1: Z axis Plummer block ; 2: Z axis select 3: cancel	Under the status of ready condition (REDAY), when you switch the mode into “CONT”, the Z axis will Continuously be uplifted after pressing this key; When you switch to “step”, it will be the uplift of manual step; Under the 3 functions of home/zero-clearing/ gotoz, this key has the Z axis select function when you need to start the single-axis operation. When you enter the status of the start line or the F/Sdefault editing or file management page, this key has the function of cancel;
	3	1: Z axis down; 2: home 3: enter/select	Under the status of ready condition (REDAY), when you switch the mode into “CONT”, the Z axis will continuously be down after pressing this key; When you start the second function, this key has the search machine tool coordinate 0-point function; When you enter the status of the start line or the F/S default editing or file management page, this key has the function of enter or select;









	4	1: A axis rotates in forward direction; 2: A axis select; 3: parameter increases; 4: F/S default select/cancel	Under the status of ready condition (REDAY), when you switch the mode into "CONT", the A axis will Continuously be rotated in forward direction after pressing this key; When you switch to "step", it will be the rotate in forward direction of manual step; Under the 3 functions of home/zero-clearing/ gotoz, this key has the X axis select function when you need to start the single-axis operation. Under the status of FRO/ SRO/ SJR parameter modification, the current parameter value will increase after pressing this key. When you switch to the status of F or S, this key will select the default value as the effective value or select G code setting value as the effective value;
	4	1: A axis rotates in inversion direction; 2: Probefunction 3: Parameter decreases; 4: F/S default modification	Under the status of ready condition (REDAY), when you switch the mode into "CONT", the A axis will Continuously be rotated in inversion direction after pressing this key; When you switch to "step", it will be the rotate in inversion direction of manual step; Under the status of starting the second function, this key has the probefunction; Under the status of FRO/ SRO/ SJR parameter modification, the current parameter value will decrease after pressing this key. When you switch to the status of F or S, this key will enter the default value editing status after pressing this key;
	2	1: FRO/SRO/SJR /F/S/G; 2: file copy	Under the processing page and the status of ready condition (REDAY), it will switch to the 8 status of processing parameter FRO/ SRO/SJR/F/S/G soft limit and ready condition; under the processing status(busy), it can only switch to the 3 status of FRO/SROand processing status; Under the file management page, it is the function of copying the current selected files;
	2	1: Second function start 2: file paste	Under the processing page and the status of ready condition (REDAY), it will switch to the 2nd mode status; Under the 2nd mode status, you can press the corresponding pieces to start the 4 functions of home, zero-clearing and gotoz as well as probe; When you press this key again, it will quit; Or some operation can automatically quit the 2nd mode. Under the file management page, it will paste the files which have been copied to the current folder after pressing this key;
	2	1: mod switch 2: file delete	Under the processing page and the status of ready condition (REDAY), it can switch the manual mode of each axis. Totally there are 3 manual mode, which are "step", "CONT", "MPGpattern"; Under the file management page, it will have the function of deleting the current selected file after pressing this key;

Table 3-1 List of Keys 'function

3.3 Operation methods of common function

This section focuses on describing the common functions of keys 'combination operation. In the real operation, please avoid the operation of pressing the 2 keys at the same

time. For example,  + , indicates that you should firstly press , and then

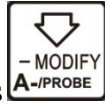

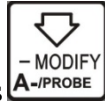
release this key; Next, please press  and release it.

3.3.1 File Management



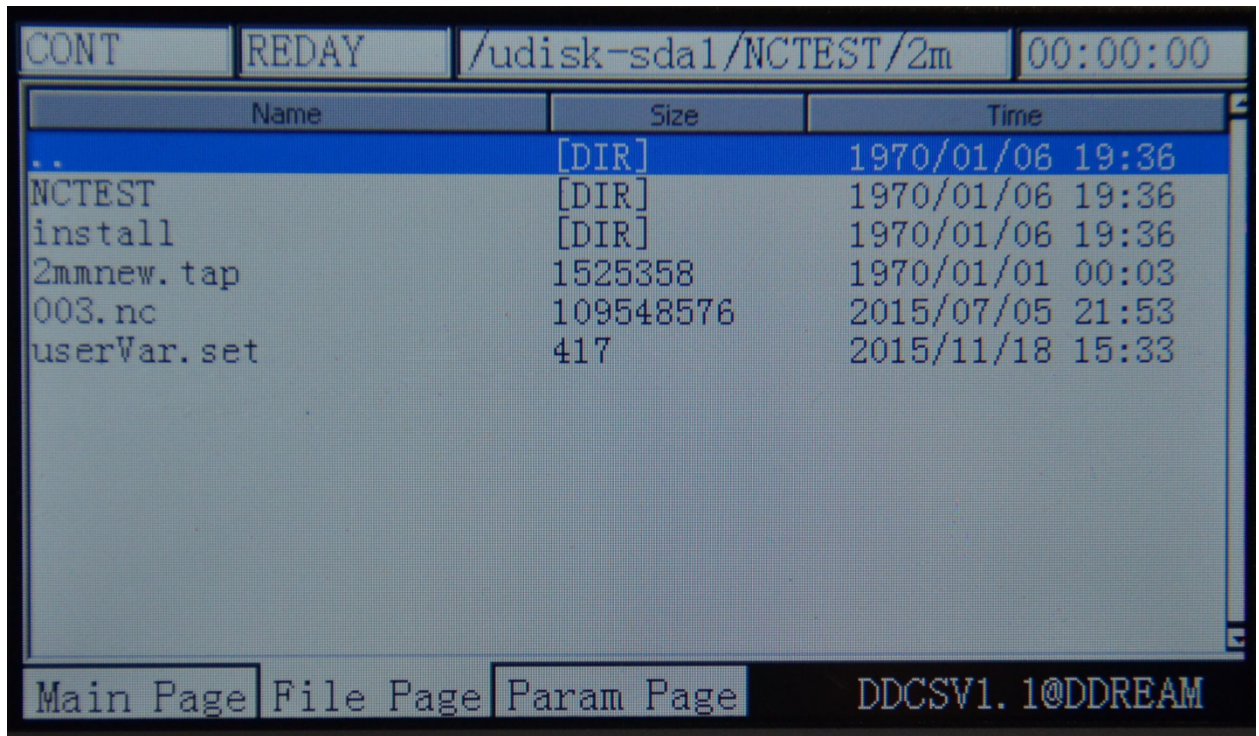

In the homepage, please press  to enter the file management page, Just as Picture 3-5 shows:



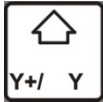

Picture3-5. File management page

At this time, it displays all the folders and files in the root directory. The corresponding size column of folders 'namewill display【DIR】, The corresponding size column of files shows the size of this file. The blue strip indicates the current valid target location.

Press  to move forward;



Press  to move backward;

Press  to quit the file management page;

Press  to enter; If the current target item is “..” , it will quit the current directory and enter the last directory. If the current target item is folder, it will enter the target folder. If the current target item is the target G code file, it will select the target file; If the current target item is *.set file, it indicated that the system is loading all the configuration of *.set file.

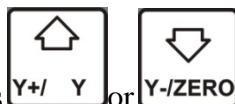
1) Copy the file

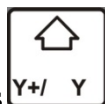

In the file management page, press  or  to select the target file. Just as the Picture3-6 shows:

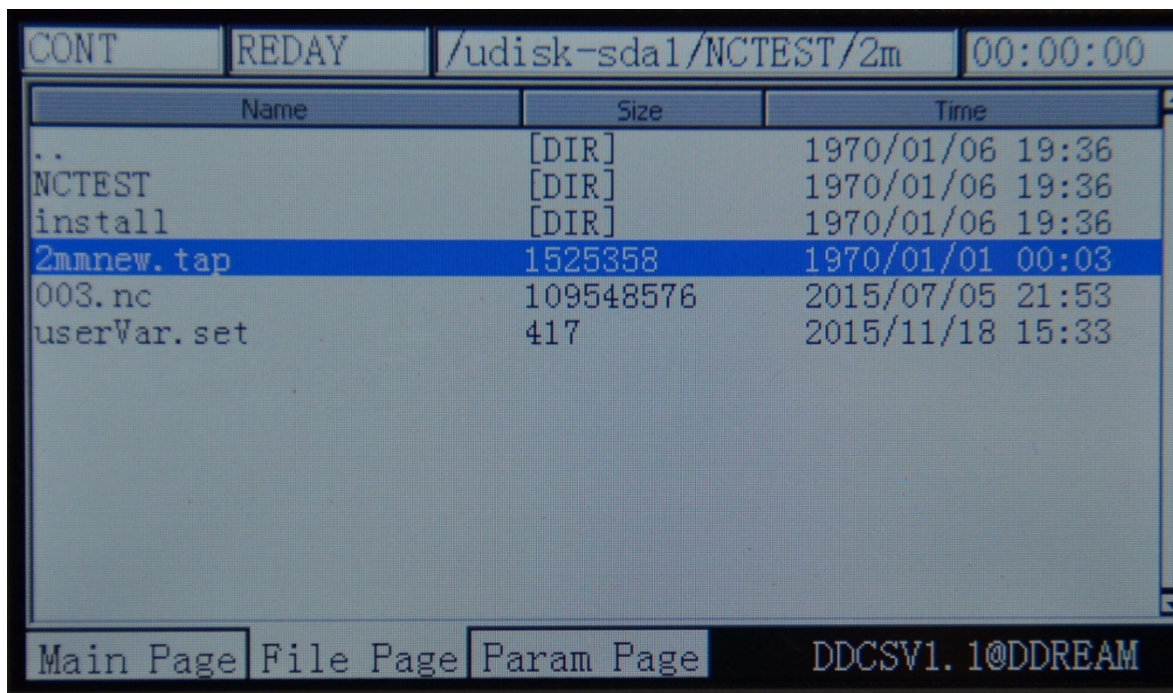

Picture3-6. Select 2mmnew.tap file and copy the file



At this time, the 2mmnew.tap file is selected, and please press the key , which indicates that the 2mmnew.tap is copied to the back-stage.

2) Paste the file

As the picture 3-7 shows, switch to the target file.

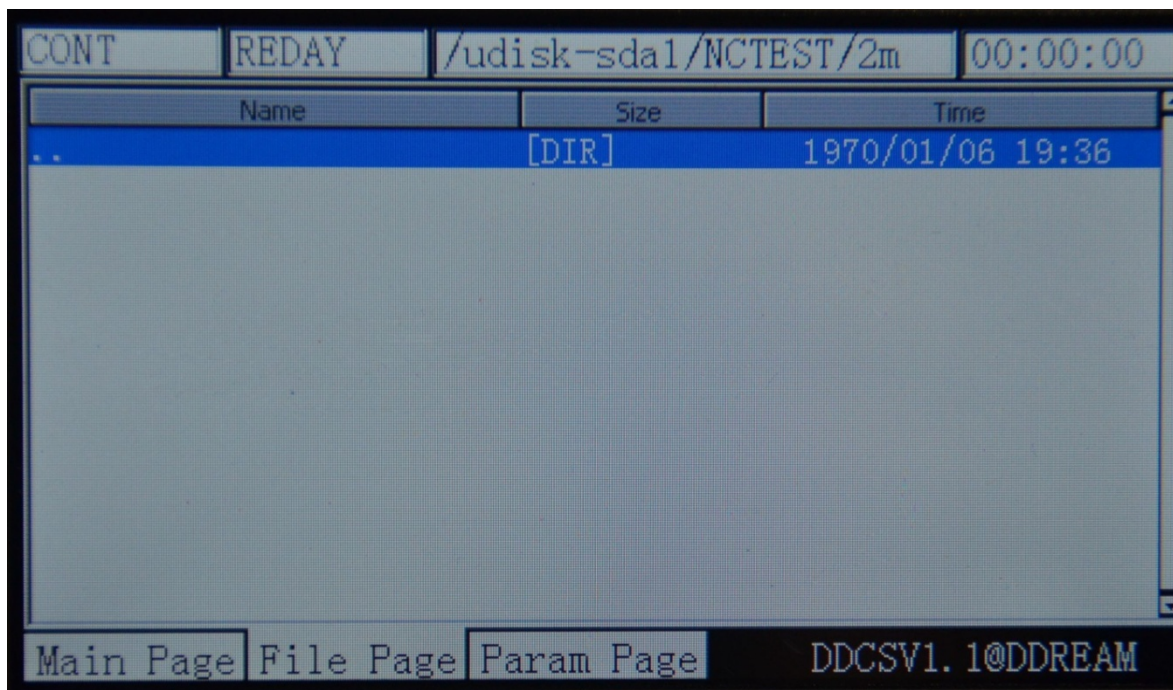

Picture3-7. Switch to the target folder

At this time , there is no 2mmnew.tap file in the target folder,, press to paste the 2mmnew.tap file to this directory. Please look at picture 3-8 for reference.

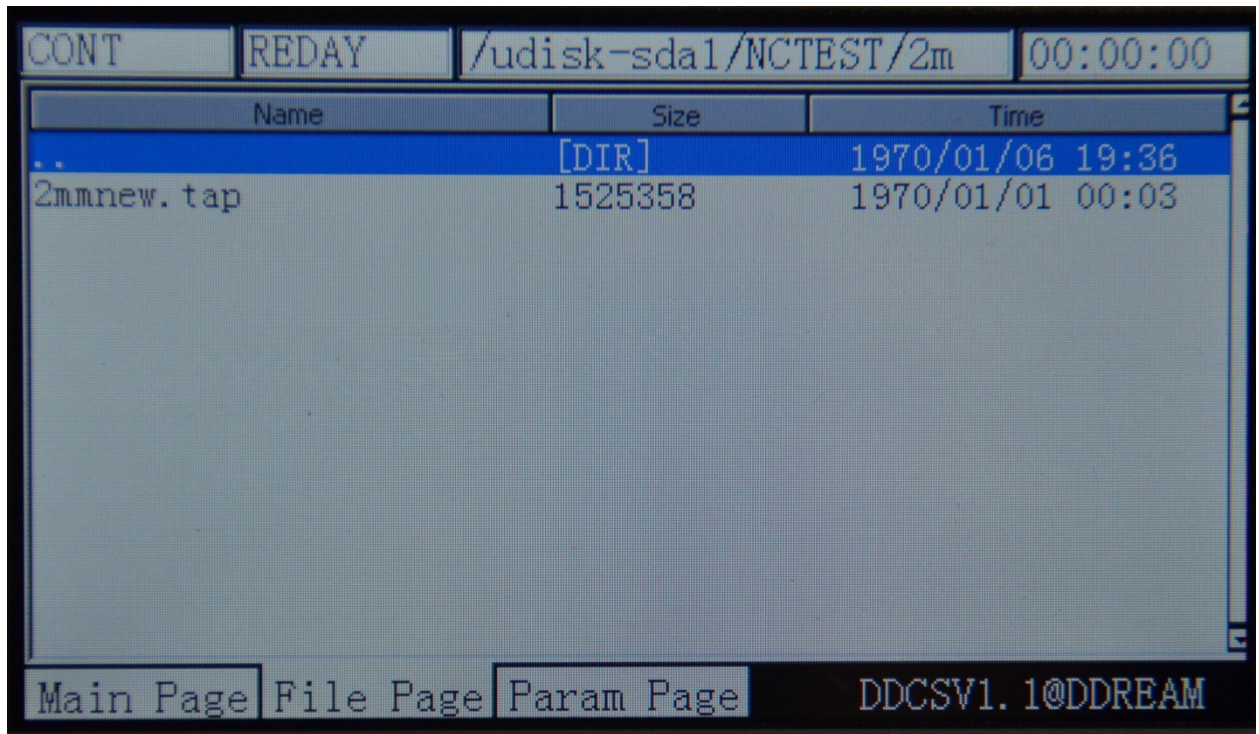

Picture3-8. Paste the 2mmnew.tap file to this directory

3) Delete the file



Press **Y-/ZERO** to move the blue strip to the file which is required to delete. At this time, move to the 2mmnew.tap file. Please look at picture 3-9 for reference.

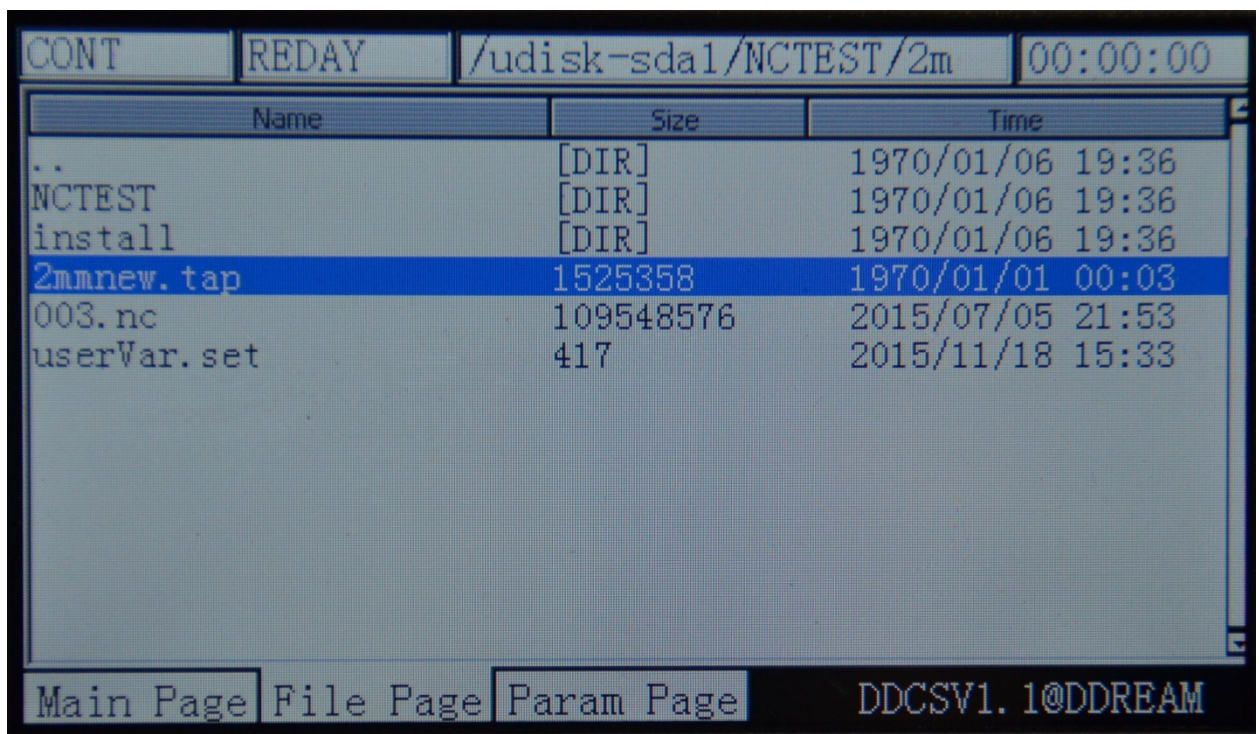

Picture3-9. Move the blue strip to the 2mmnew.tap file

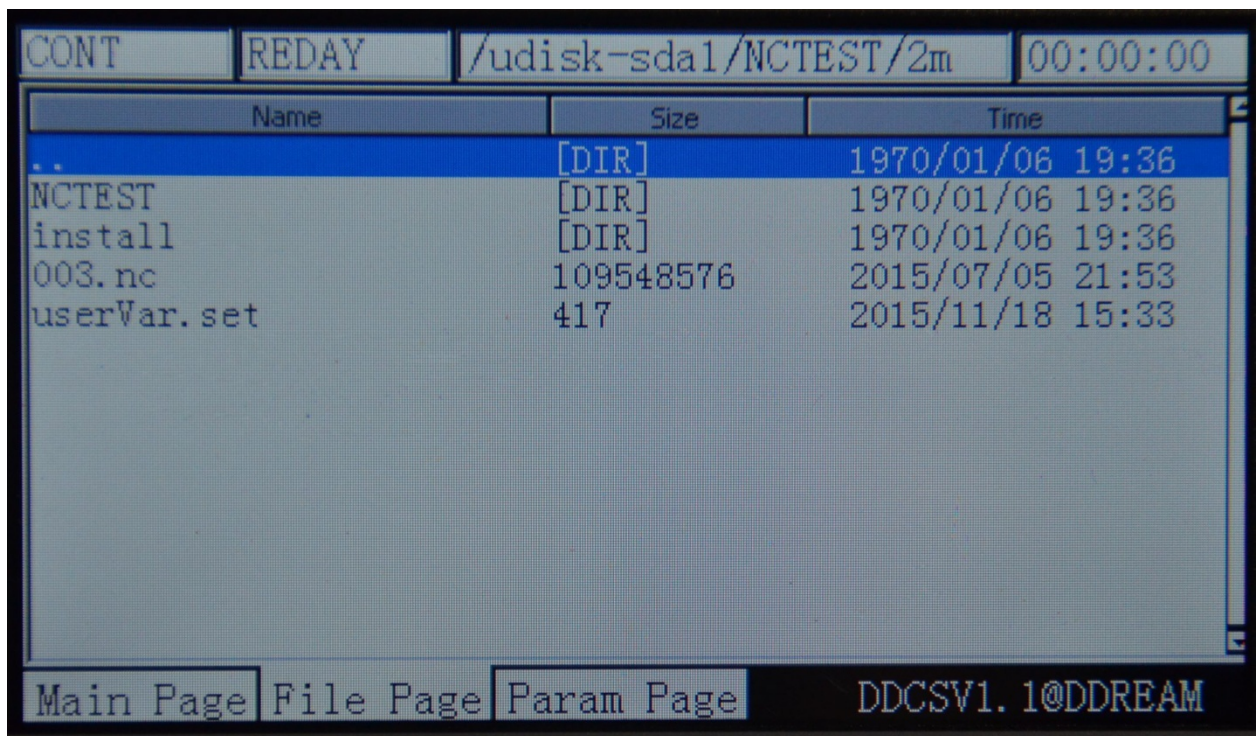

MODE

Press  to delete the 2mmnew.tap file. Please look at picture 3-10 for reference.

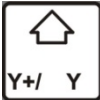

Picture3-10. Delete the 2mmnew.tap file

4) Load the G code file

Use   and  to search the G file which is required to load ,as picture 3-11 shows:

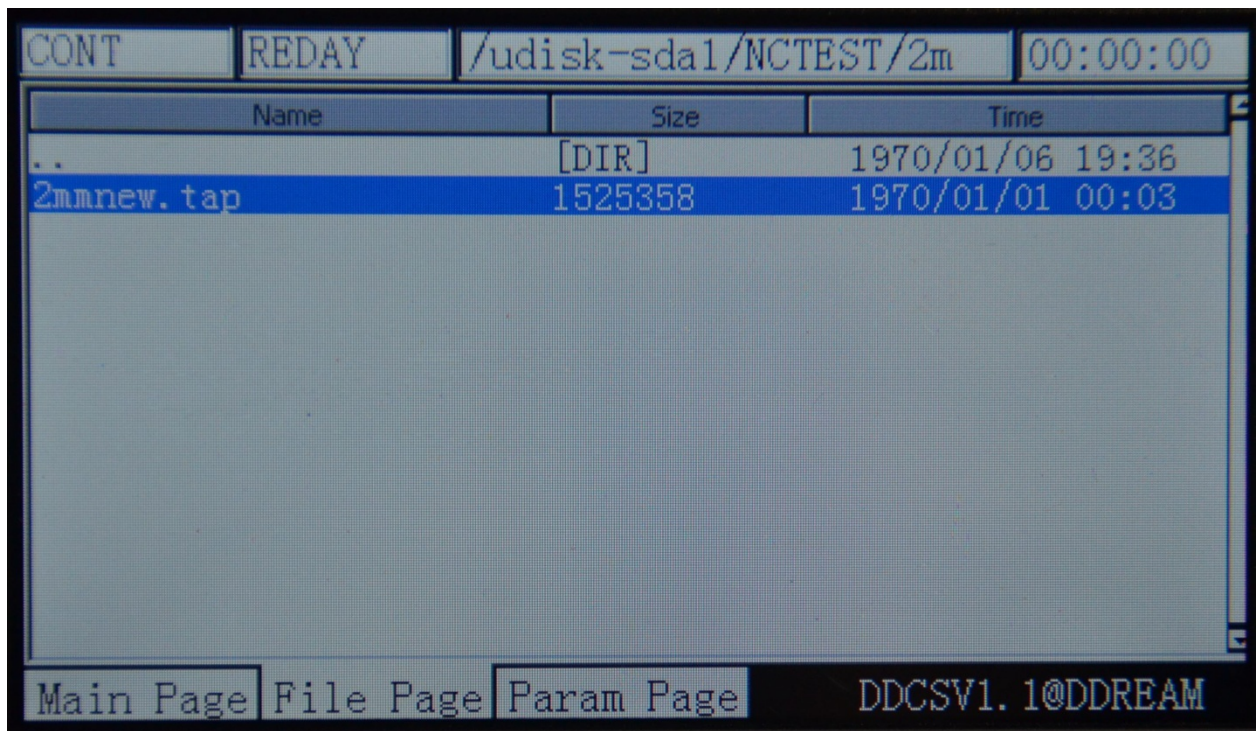

Picture3-11. Search for the file2mmnew.tap



Press  to load this G file, and the system will automatically be back to the processing page, as the Picture3-12 shows. At this time, the display area of processing file has displayed the name of file.

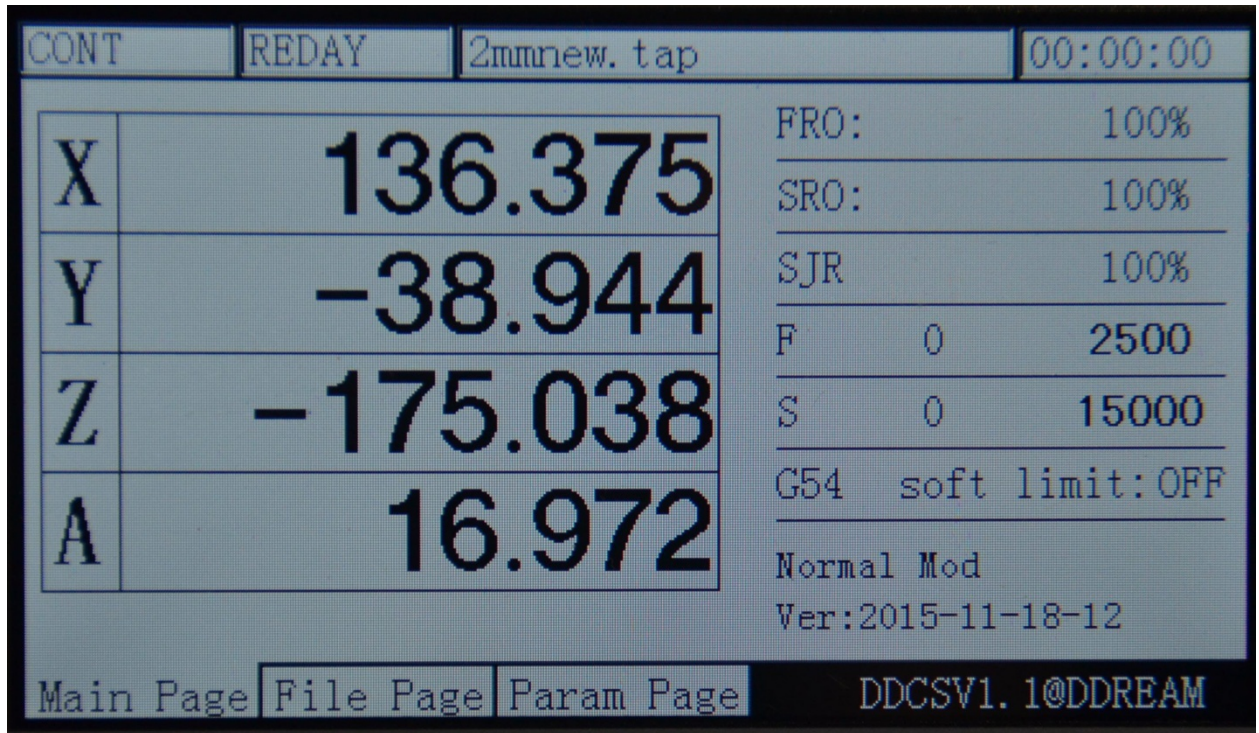



Picture3-12. After loading the file 2mmnew.ta, it will automatically be back to the processing page





3.3.2 Automatic operation

1) Start automatic operation



After loading the processing file, press  to ensure the operation status column to display “REDAY”, At this time, it needs to set the goto zero in accordance with the real needs. For example, if the G code file takes the work piece center as the 0-point, the tool nose can be moved to the center of the work piece at this time and then when the current coordinate is 0-clearing, the center of the work piece is the work piece 0-point. This operation will be

described in detail in the following sections. After finishing the setting, press  to start the automatic processing according to the G file. In the process of automatic processing, Only

the function of ,  and  is valid. The key  can only set the value of FRO and SRO. Please look at Picture3-13 for reference. Look at the operation line. The photo shows that it has operated to the 5148th line. In the process of operation, you can

press  to switch the display status into the coordinate display or tool path display. Just

as the picture 3-13 shows. The picture3-14 and picture3-15 are the tool path display. In the status of tool path, the screen will also maintain the tool path status after the end of processing. Please look at the picture 3-16 for reference.

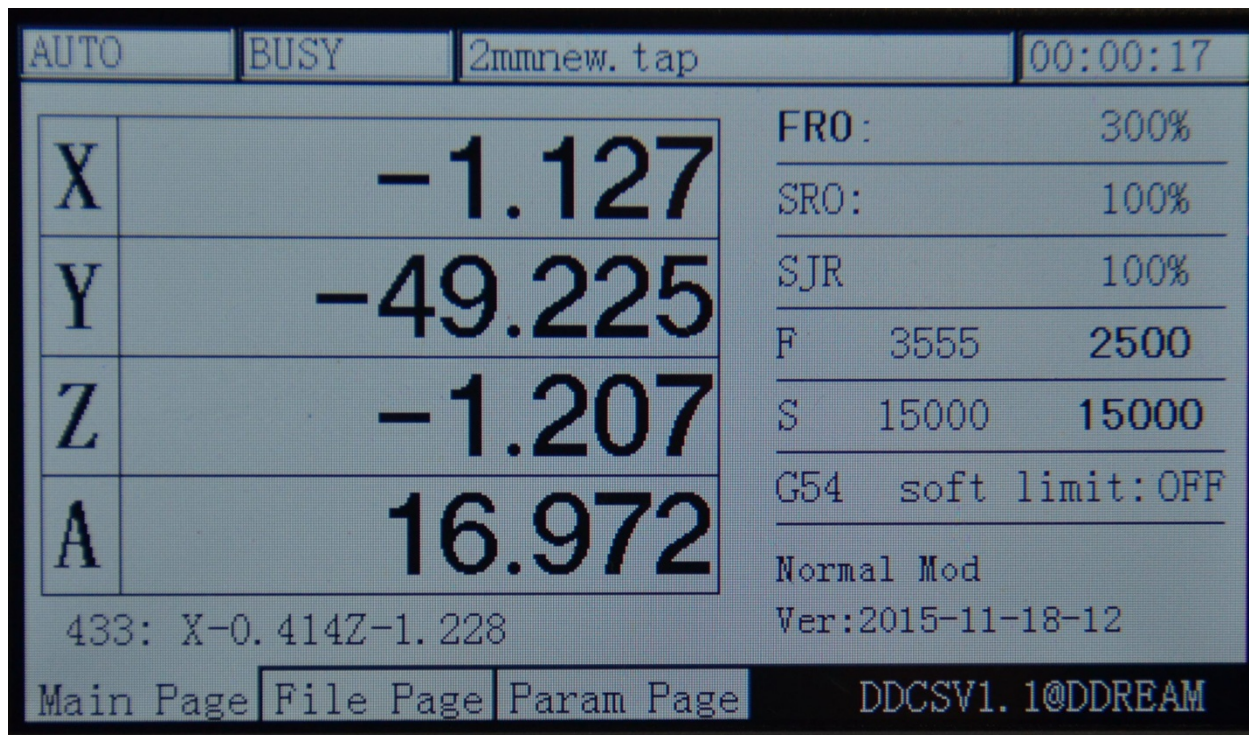

Picture3-13. Start automatic processing

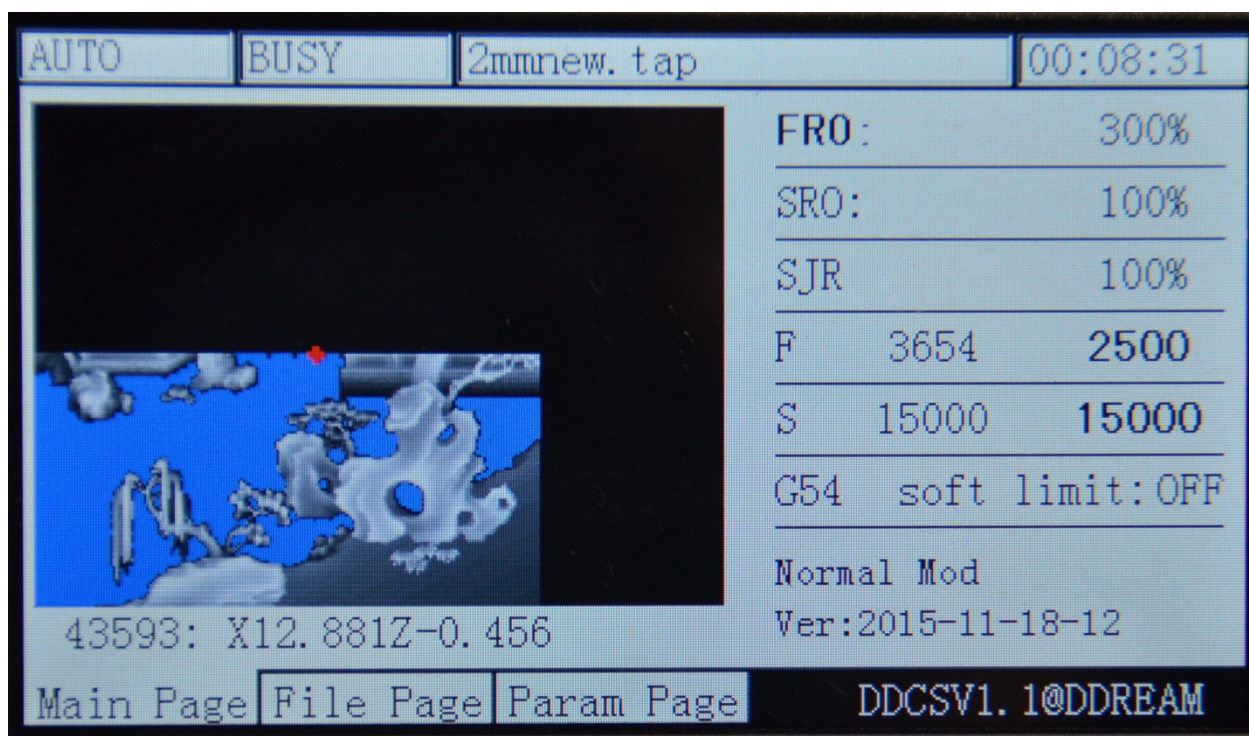

Picture3-14. Status of tool path when the processing is approaching half

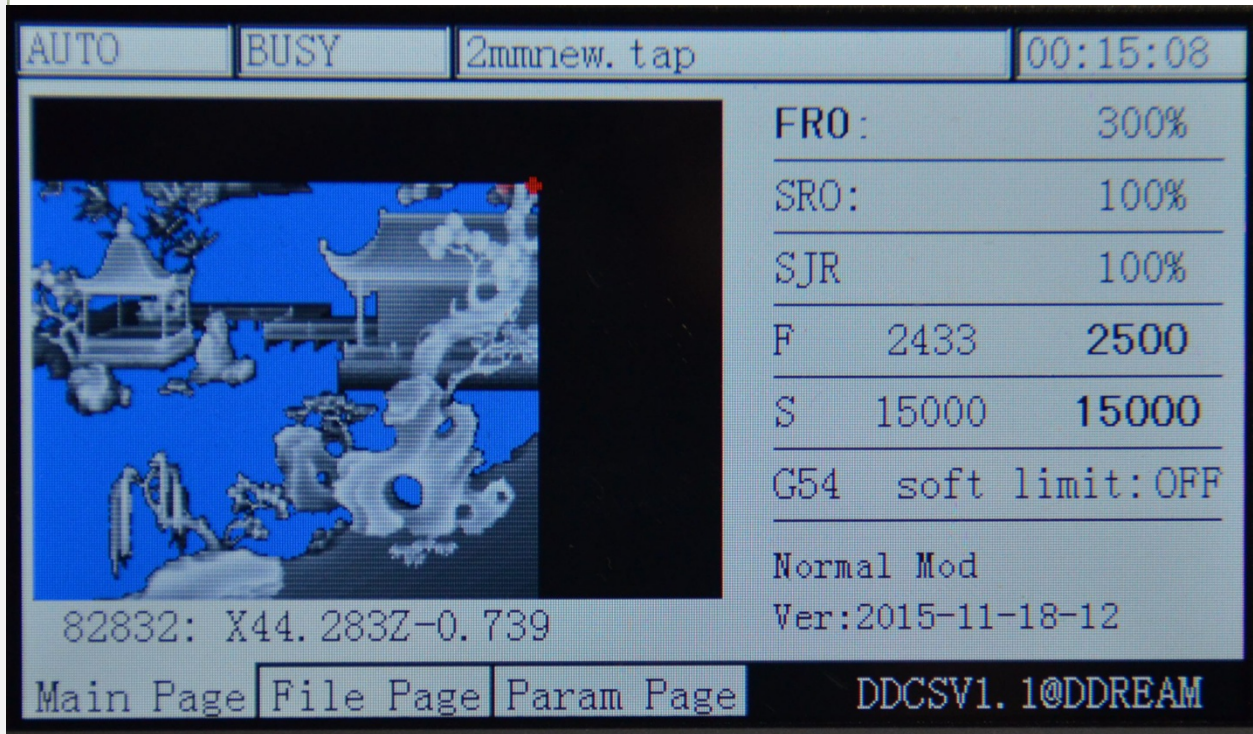

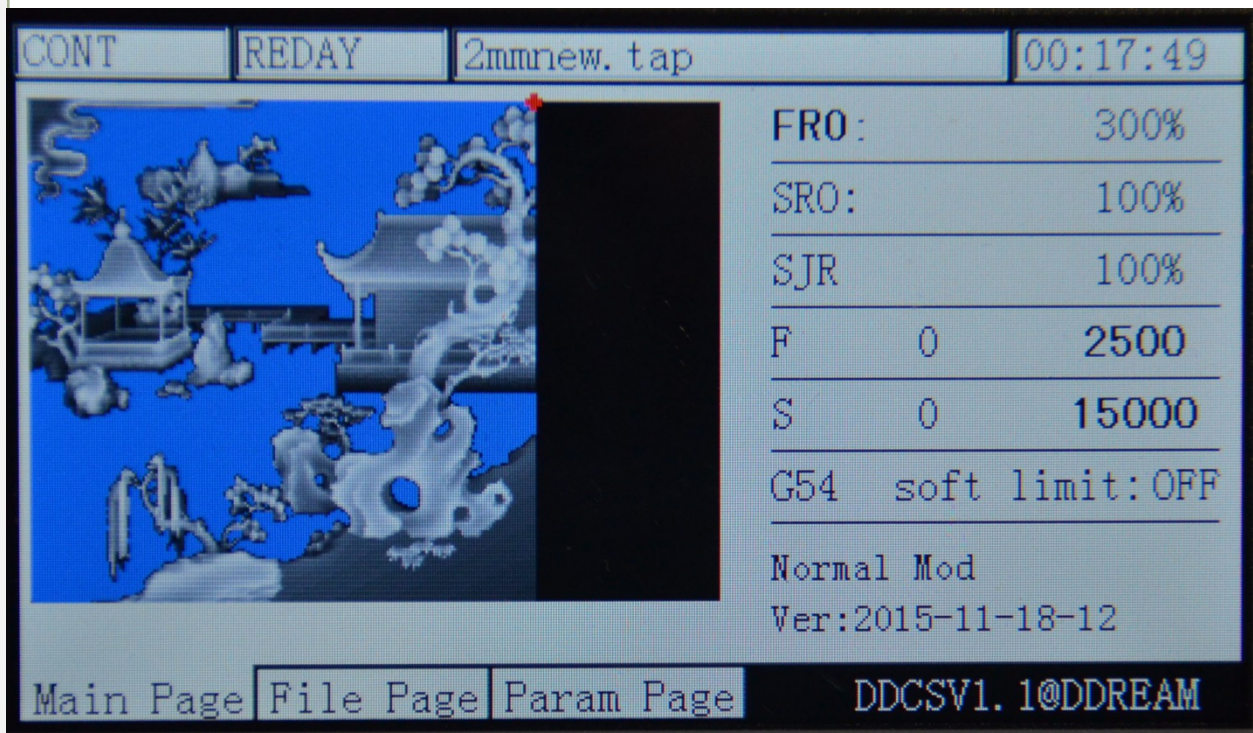

Picture3-15. Tool path display status when the processing is approaching to end



Picture3-16. Tool path display status when all the processing is end

2) Breakpoint operation

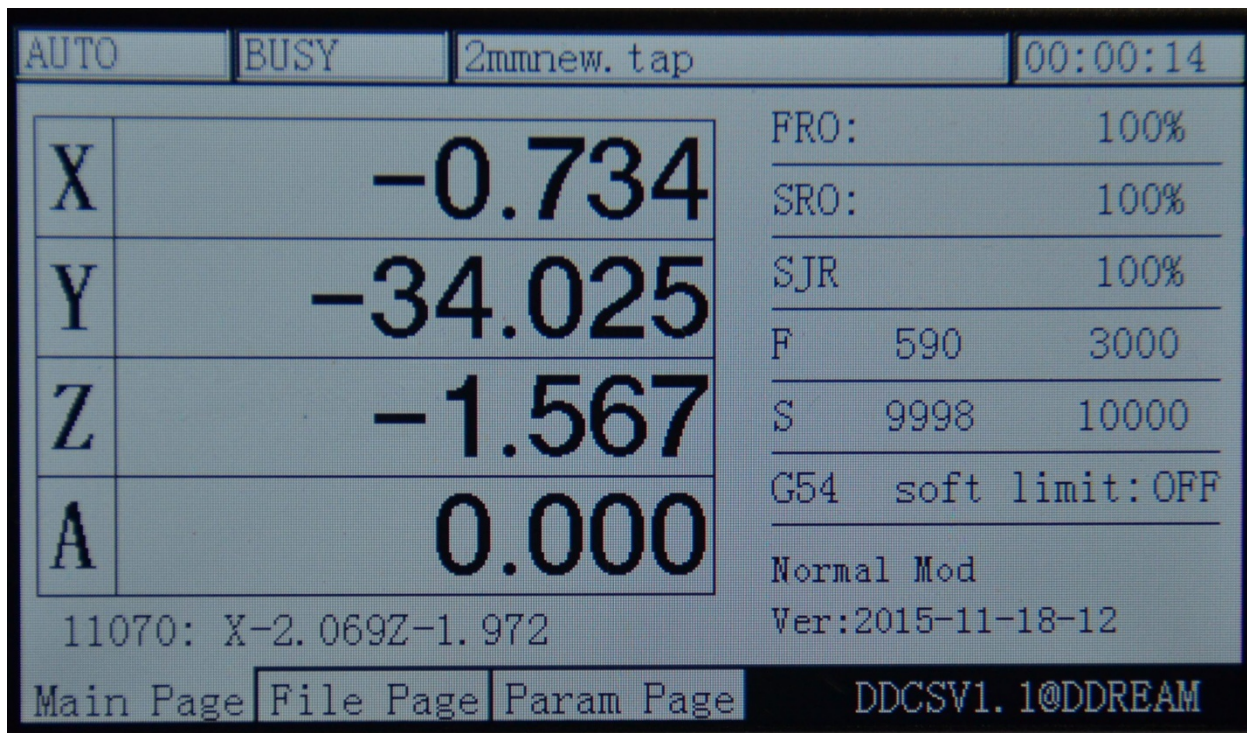

Press  to enter the 2nd mode. When under the 2nd mode, press  to enter the breakpoint operation. At this time, the equipment begins to operate from the last record breakpoint. Note: When this system presses , it will automatically produce a breakpoint. When it is in outage, it will also automatically record the breakpoint. As the picture3-17 shows,

it begins processing from the 26thline at this time. The goto break is to ensure the reliability. The display position of file's name is under the goto break status and the display content includes the file directory.



Picture3-17. Breakpoint operation

3) The designated line begin to operate

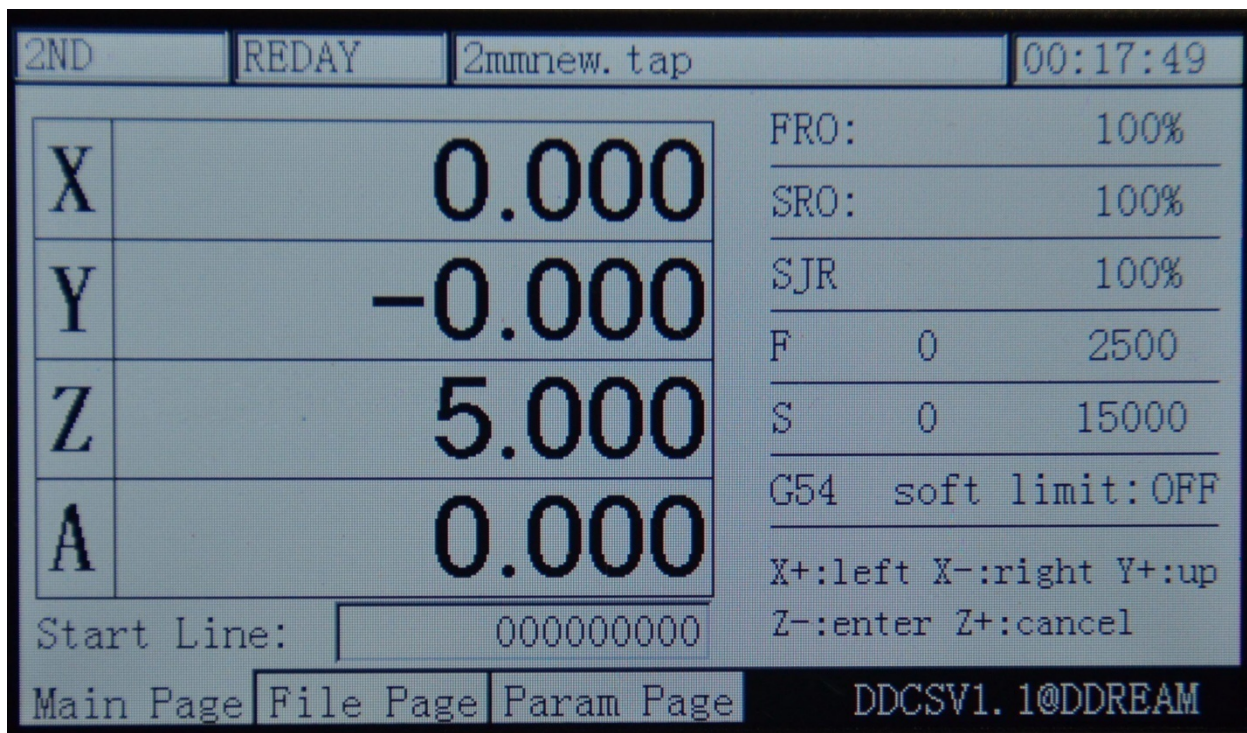

Press  to enter the 2nd mode. When entering the 2nd mode, press  to enter the designated line to processing. At this time, the positions of current line will pop-up the textbox indicating to modify the start processing line.

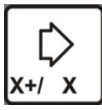

Picture3-18. Enter the designated line processing mode

As the picture 3-18 shows, the black 0 indicates the position of cursor. At this time, use

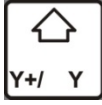

to move the cursor left and right. Use  and  to change the value that the cursor signified. As the picture3-19 shows, the start line is modified to 11000th line.

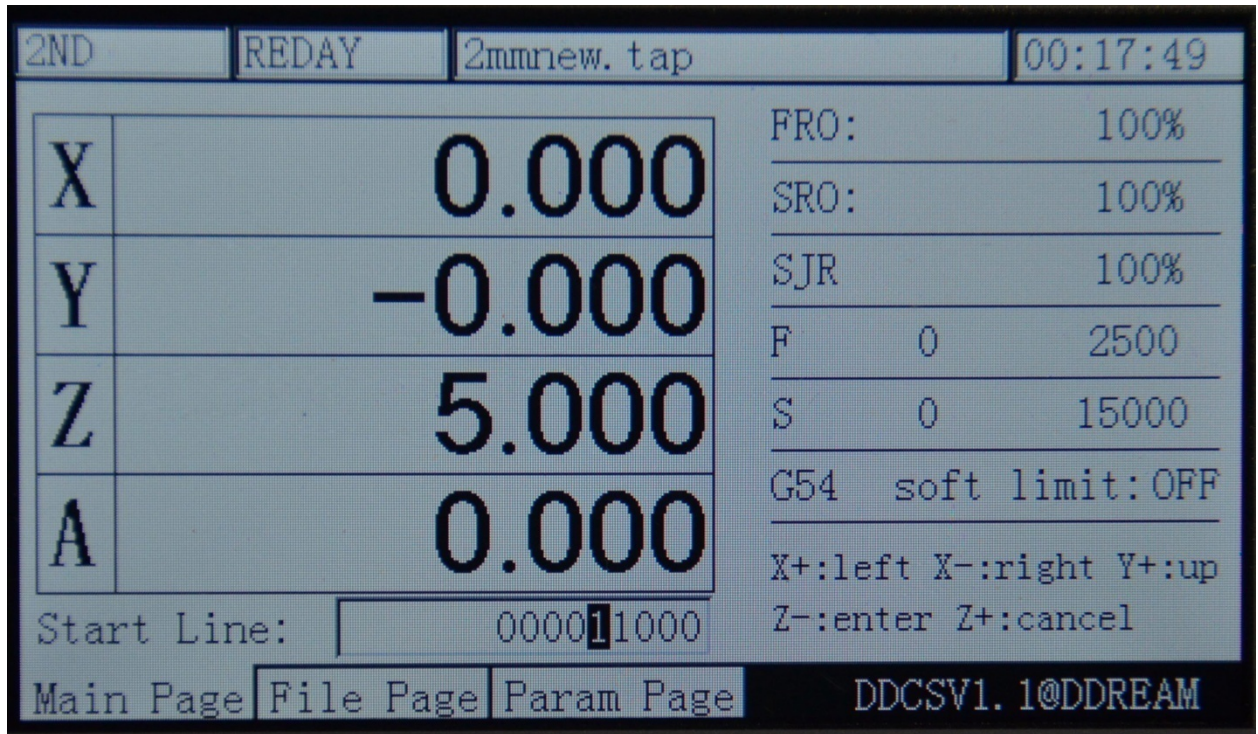

Picture3-19. Modify the start line to 11000th line



At this time, Press  enter to start the designated line to conduct the automatic processing. As the picture3-20 shows, the designated line processing will firstly conduct the grammatical analysis of the designated line and then begin to processing. In general, the value of start line is large and the process of grammatical analysis takes a long time. So the real test of 600,000 lines needs about 15 minutes to do the grammatical analysis. As the picture 3-21 shows, it begins to processing from the 11000th line.

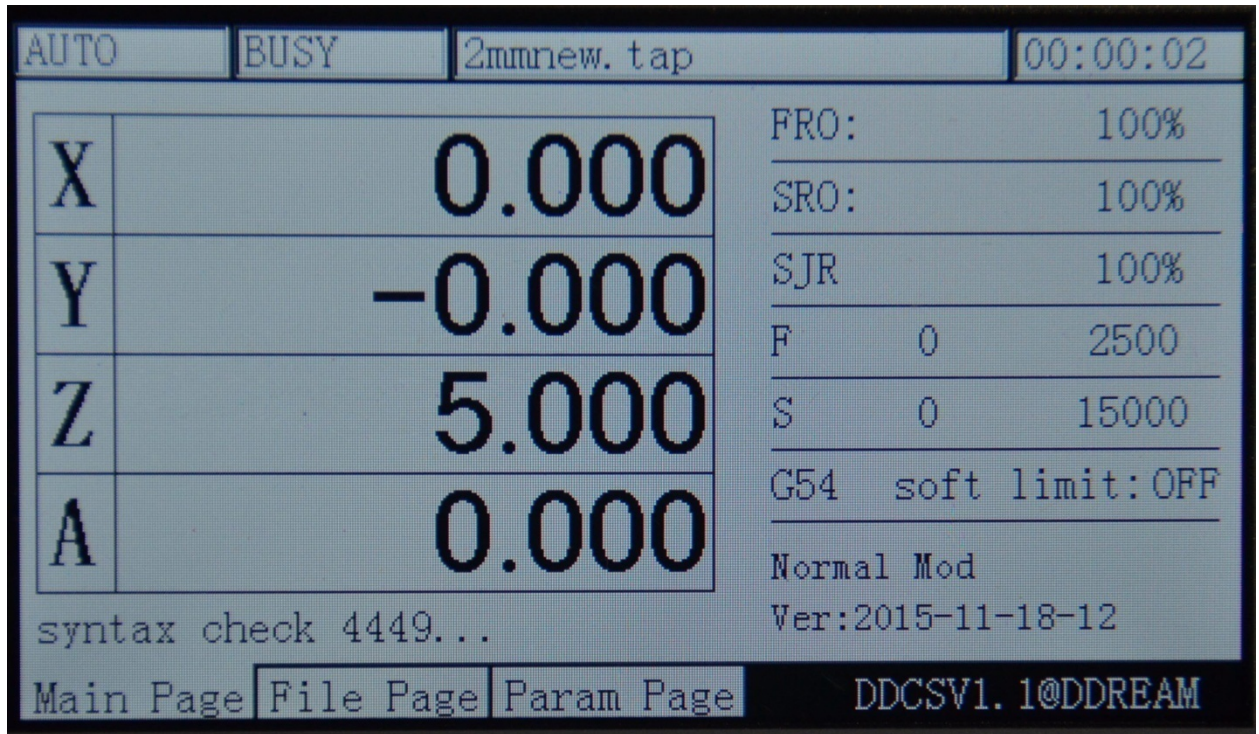

Picture3-20. Grammatical analysis after designating the start line

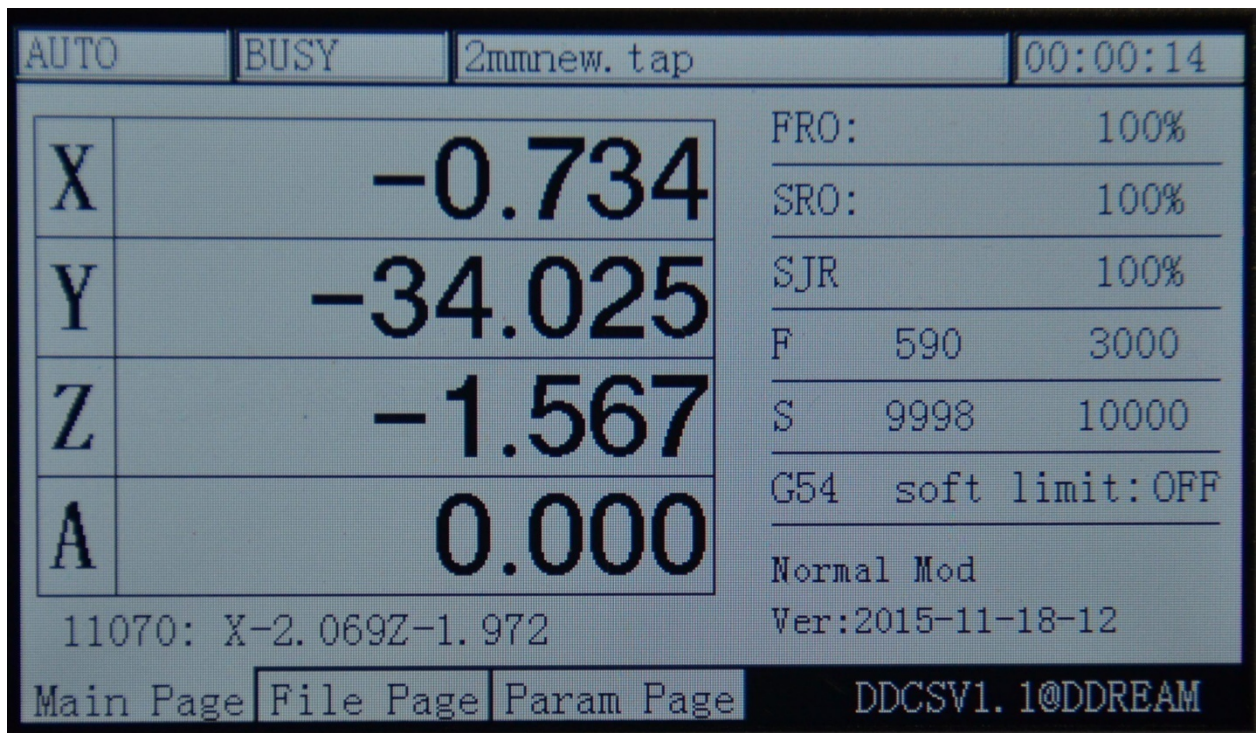

Picture3-21. Begin to processing from the 11000th line and switch to image model

4) Pause in operation





In the process of operation, press the key  to pause the procedure. At this time, the operation status column will display “REDAY” and the Z axis will lift the tool to the height of 5mm, and the spindle will not be closed.

5) ESTOP in operation

In the process of operation, press the key  to ESTOP the procedure. At this moment, the operation status column will display “reset” with flashing. The spindle will be stopped.

6) Start/stop spindle

Only when the operation status column displays “REDAY” can the spindle be manually started or stopped. In the status of starting the spindle, please press the key  to close the spindle. Under the status of closing the spindle, press the key  to start the spindle. When the operation status column displays “reset” and “busy”, all these operations can't be done.



3.3.3 Manually adjust the position of spindle

When searching for the work piece coordinate 0-point or the spindle is needed to move to a certain position, it needs to manually adjust it. The manual adjustment can be decided into 3 kinds of movement modes, which are manual step, manual step and MPG. By pressing the

button , the 3 kinds of mode can be switched.

1) Manual step in X axis

By pressing , the feed status will display “step”, thus entering the manual step mode. As the Picture 3-22 shows, the MPG rate parameter displays the manual step stepper value at this moment. The current value is 1. Indicating the manual step once, it will move

1mm. At this time, press the key  to move the X axis left 1mm, and press  the X axis right 1mm. Y/Z/A and other axis moves like this.

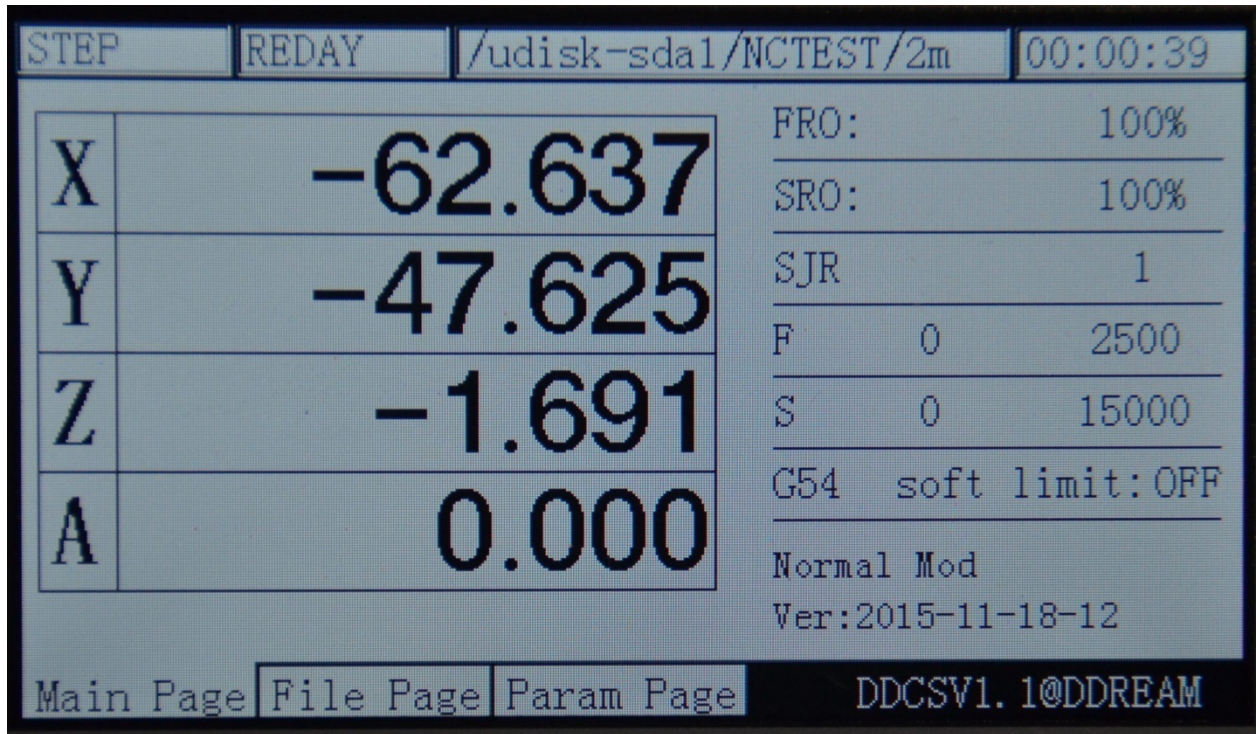



Picture3-22. Enter the manual step mode

2) Manual continuous operation in X axis



By pressing , the feed status displays “CONT”, thus entering the continuous mode. As the picture3-23 shows, the MPG rate parameter shows the MPG rate. The current value is 100%, which indicates the speed of continuous movement is the default manual speed at this

moment. At this moment, press  to move the X axis left, and press  to move the X axis right. Y/Z/A and other axis are all like this.

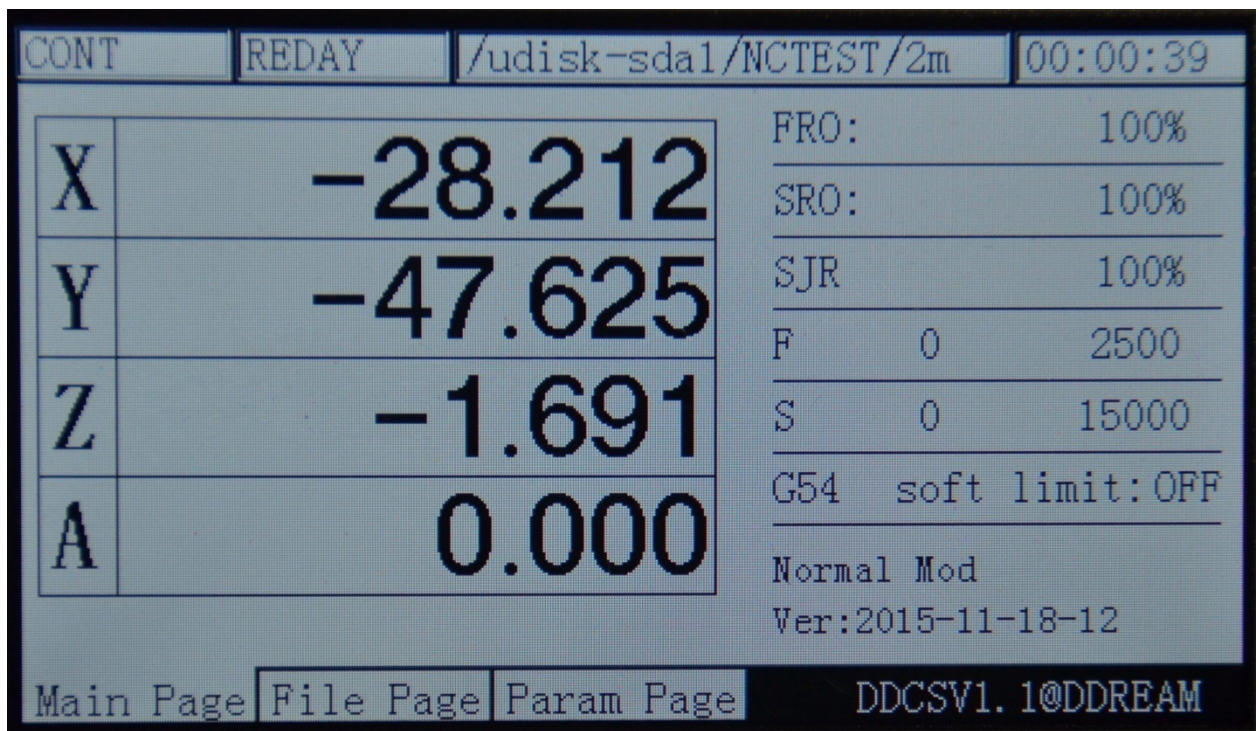

Picture3-23. Enter the manual Continuously moving mode

3) Use MPG to operate X axis



By pressing , the feed status displays “MPG”, thus entering the MPG mode. As the picture3-24 shows, select the axis of the MPG to the X at this time and the MPG is selected to the suitable position, and then rotate the MPG, thus the X axis moving with the MPG. The other axis is all like this.

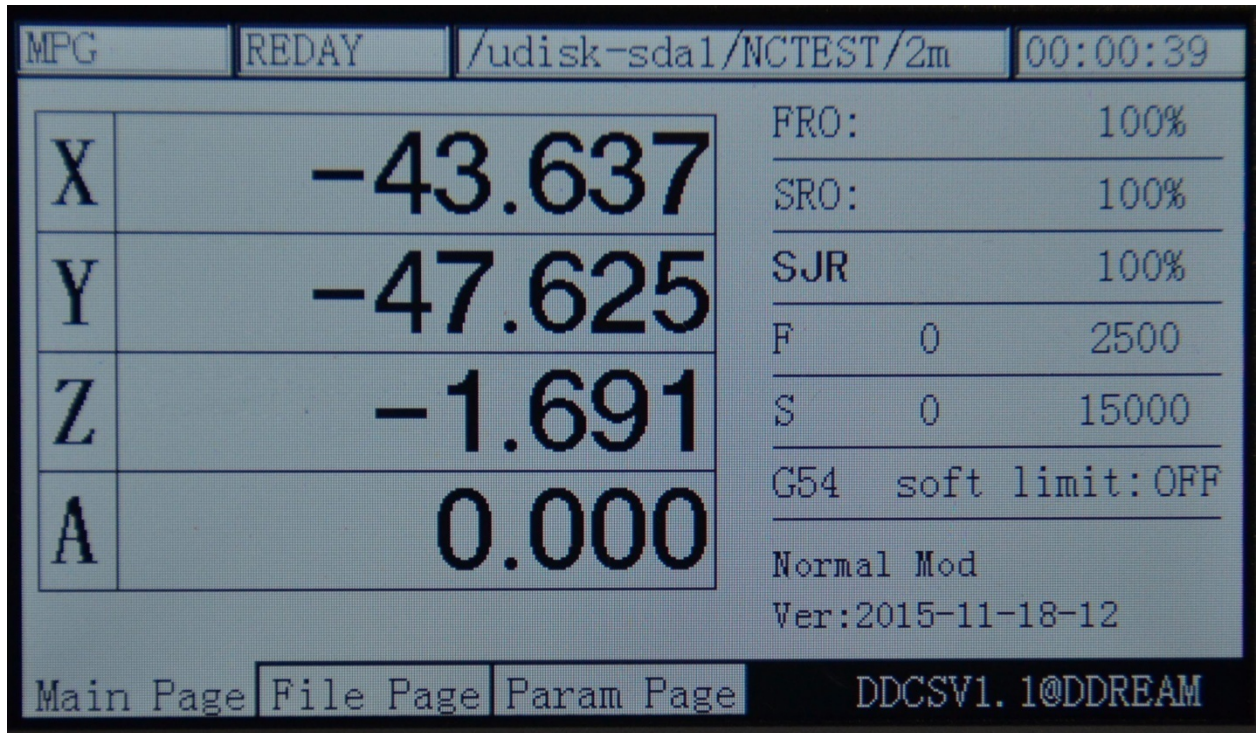

Picture3-24. Enter the MPG mode

3.3.4 Parameter value adjustment of FRO

The DDCSV2.1 operation needs lots of configuration parameter support. In order to save the page space and configure conveniently, most parts of the DDCSV2.1 adopt the configuration of file configuration. This part will be described in the next section. This section mainly talks about the parameters that are required to frequently modify the configuration. These parameters are set under the homepage, which can be modified rapidly. The rapid modification parameter includes the FRO, SRO, SRJ, F value modification, S value modification, and coordinate system select. Press the key  can make circulation adjustment of these 6 statuses.

1) FRO

The FRO is to adjust the FRO parameters. On the condition of ensuring operation status

column displays “REDAY”, press  to enter the FRO adjustment status for one time.

At this time, the words of FRO will change as the bold type. As the picture 3-25 shows, press



to increase the MPG value at this time. Press



to decrease the MPG value and

the stepper value is 10%. The picture 3-26 and picture 3-27 display the FRO values which are decreased to 80% and increased to 120%. The real feed rate $F\# = \text{the setting feed rate } F * \text{FRO}$.

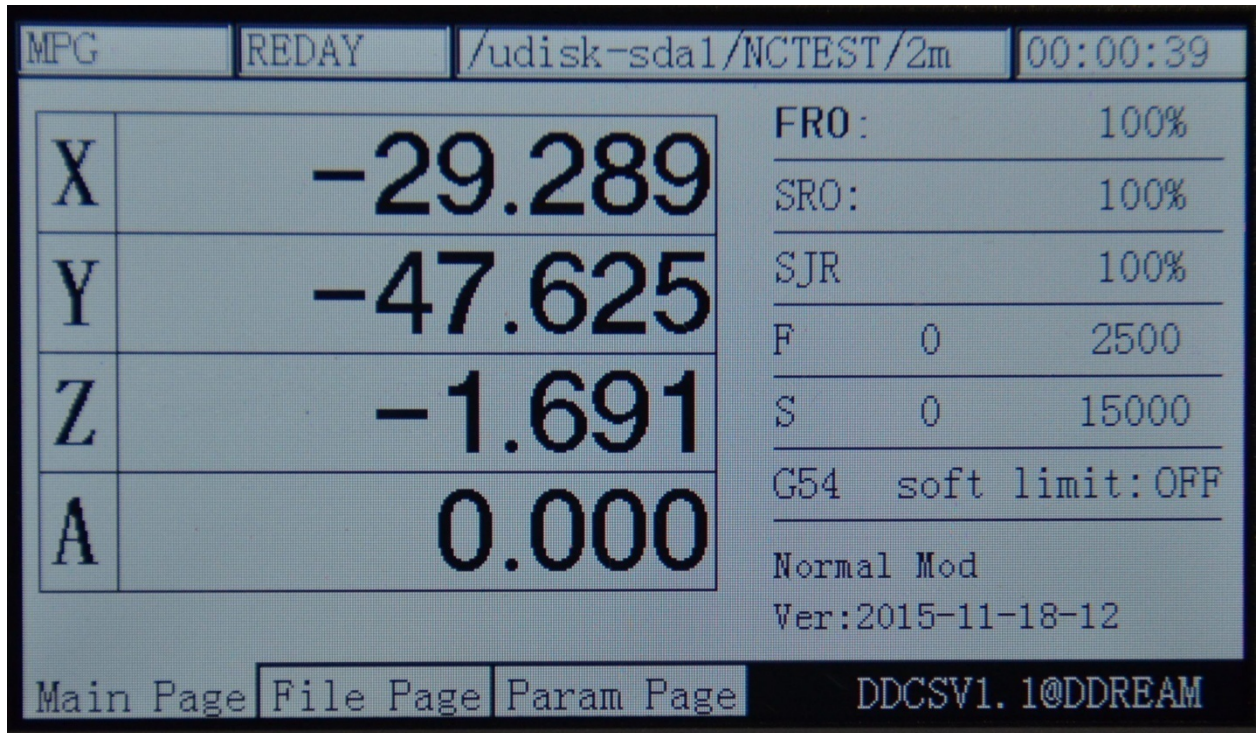

Picture3-25. Enter FRO value modification mode

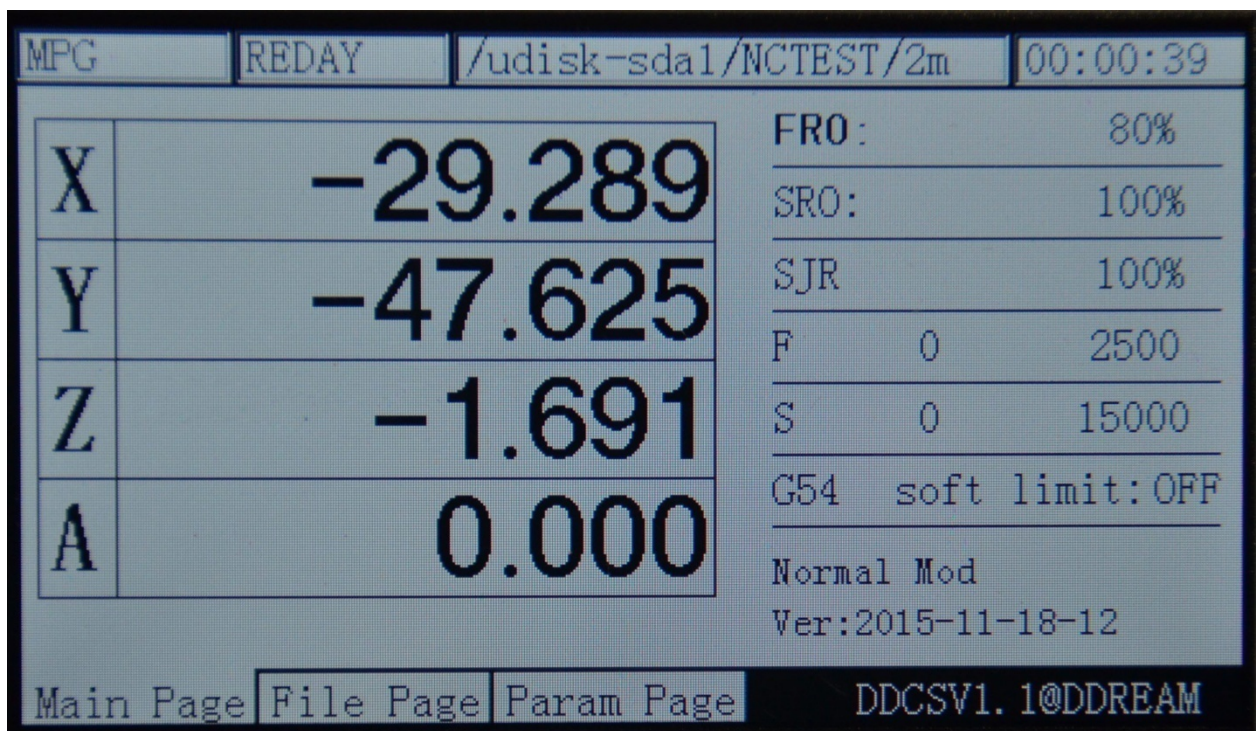

Picture3-26. FRO decreases to 80%

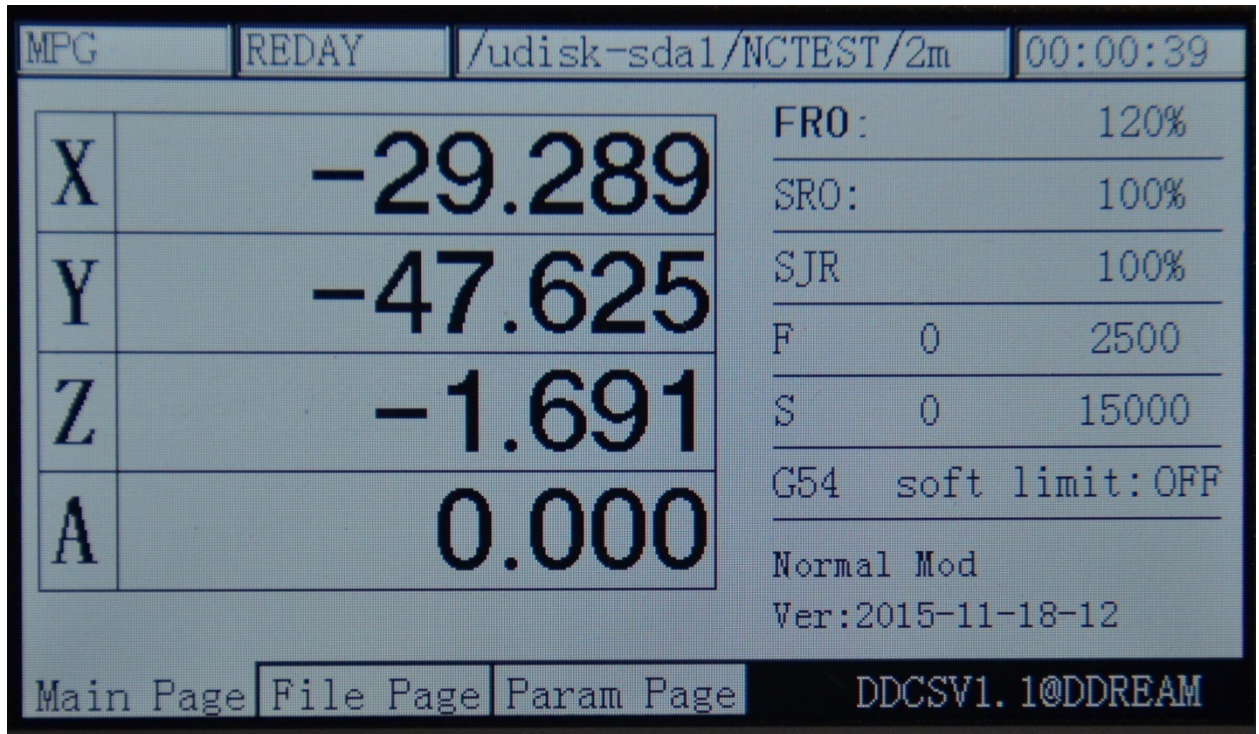



Picture3-27. FRO increases to 120%

2) SRO

The spindle adjustment is to adjust the rate parameters of the spindle's speed. In the mode

of FRO mode, press  for one time to enter the SRO mode. At this time, the words of SRO will change as the bold type. As the picture 3-28 shows, the rate value of spindle will

increase when you press  at this time, and the rate value will decrease when you press

 at this time. The stepper value is 10%. The picture 3-29 and picture 3-30 display the rate values of spindle which are decreased to 80% and increased to 120%. The real spindle speed $S\# = \text{the setting spindle speed } S * \text{SRO}$.

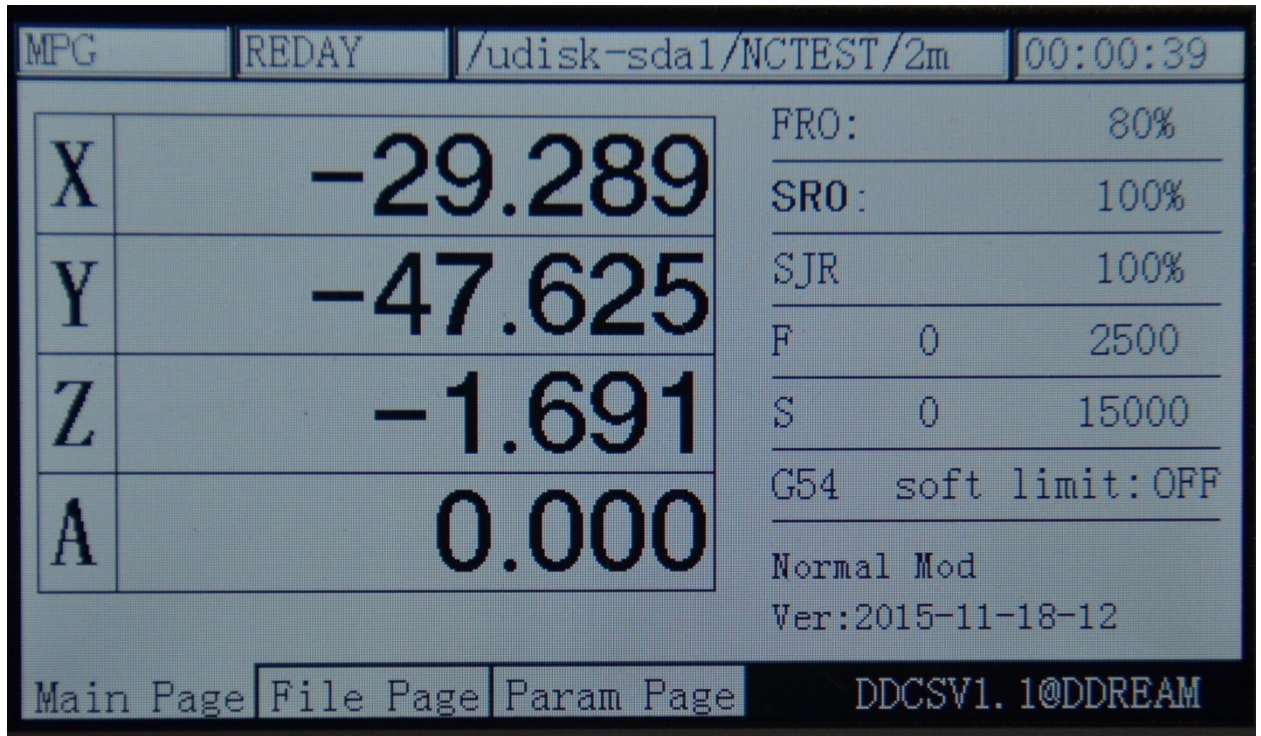

Picture3-28. Enter the SRO mode

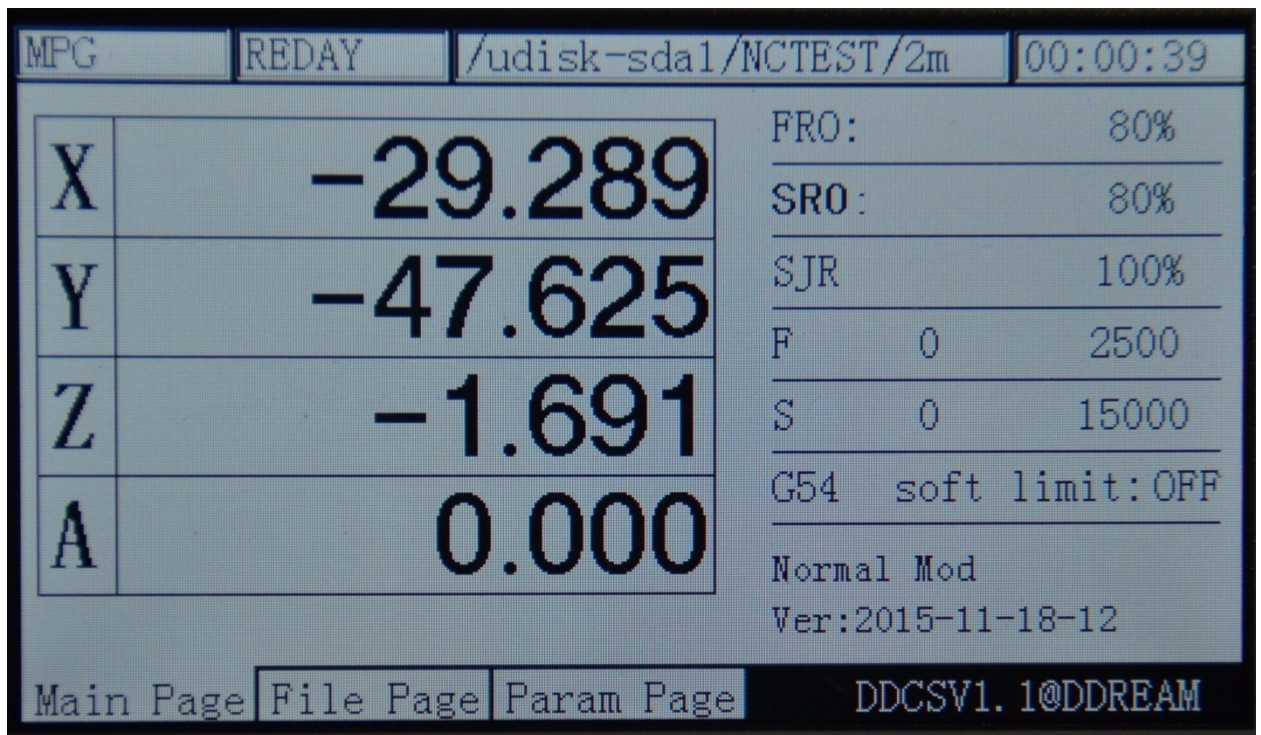

Picture3-29. SROadjusts to 80%

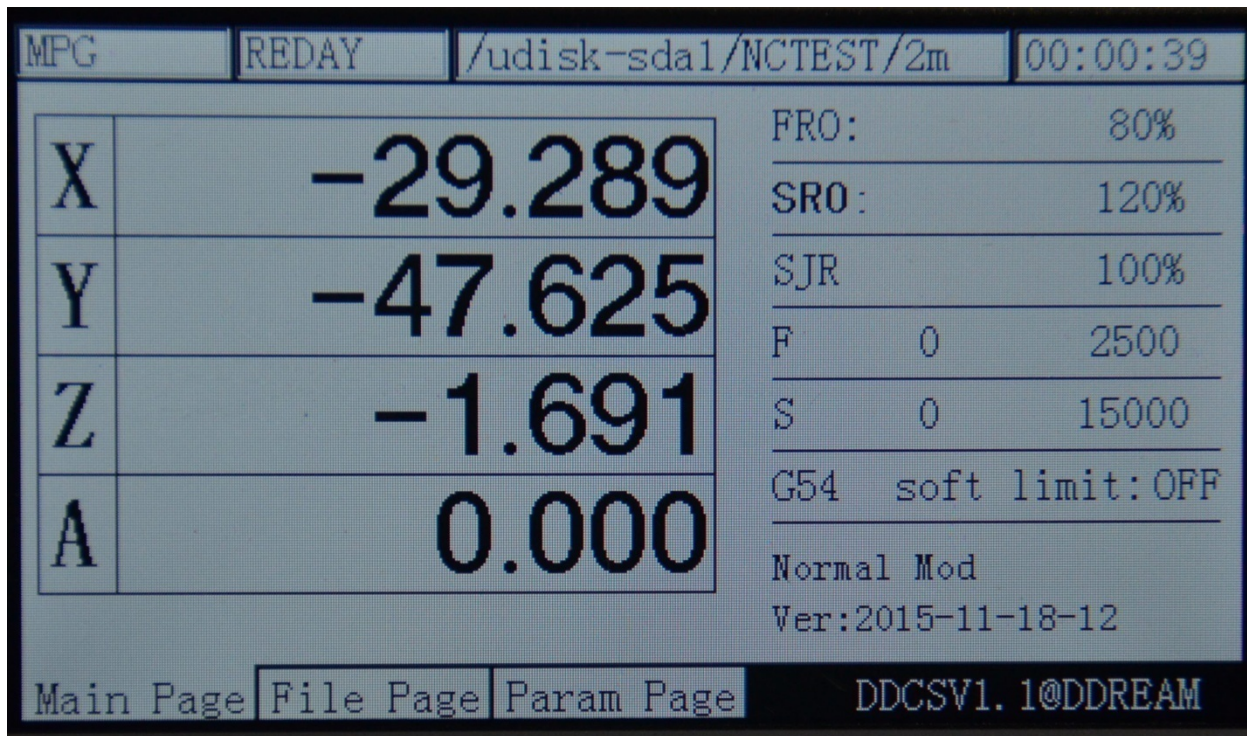

Picture3-30. SRO adjusts to 120%

3) SJR



The SJR is to adjust the manual rate parameter. Under the mode 在 of SRO, press  for one time to enter the mode of SJR. At this time, the words of manual control will change as bold type. As the picture 3-31 shows, when the feed status is in the mode of “CONT”, press



to increase the ratevalue of manual control at this time, and press



to decrease the rate value of manual control. The stepped value is 10%. The picture 3-32 and picture 3-33 display the rate values of spindle which are decreased to 80% and increased to 120%. The real manual control speed $FS\# = \text{the setting spindle speed } FS * SJR$. When the feed status is in the

mode of “step”, the SRJ stands for the manual step stepper value at this time. Press 



to increase the SJR value at this time. Press  to decrease the SJR value. As the picture 3-34 shows, the current modification SJR value is 10, which indicates that under the manual step mode, the corresponding axis will operate 1mm when you press it once.

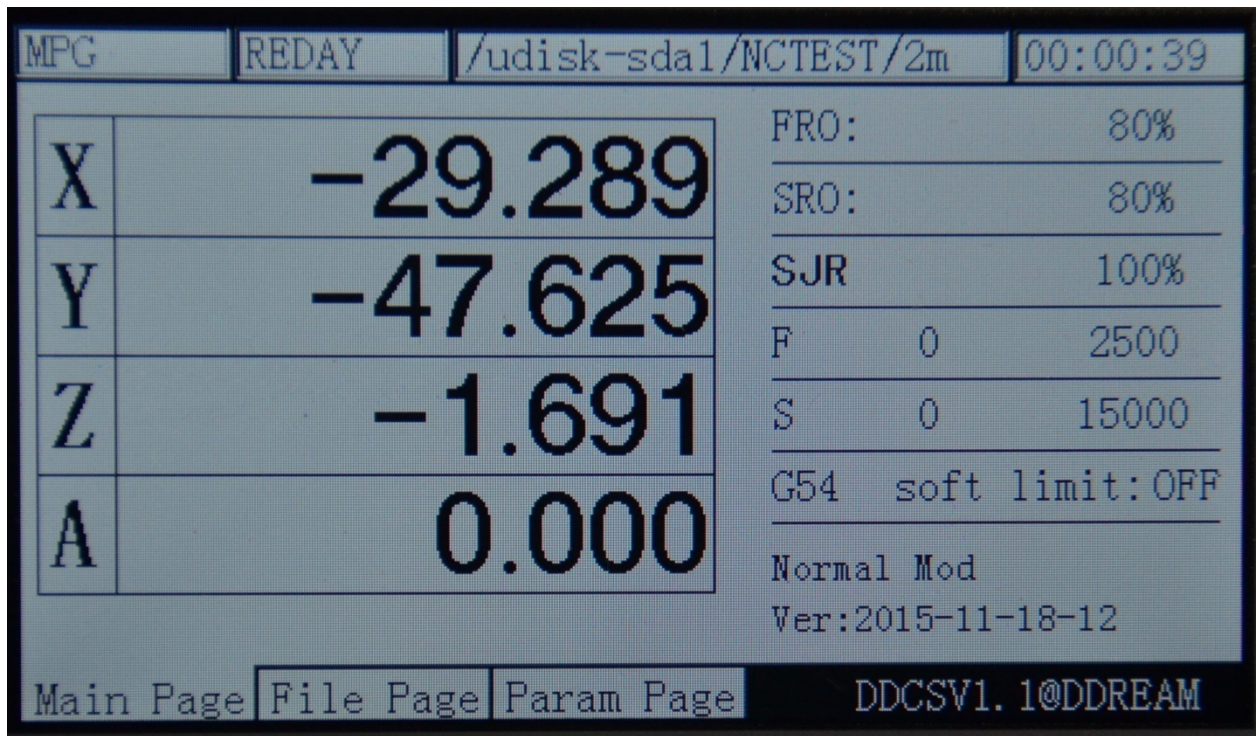

Picture3-31. Enter the mode of "SJR"

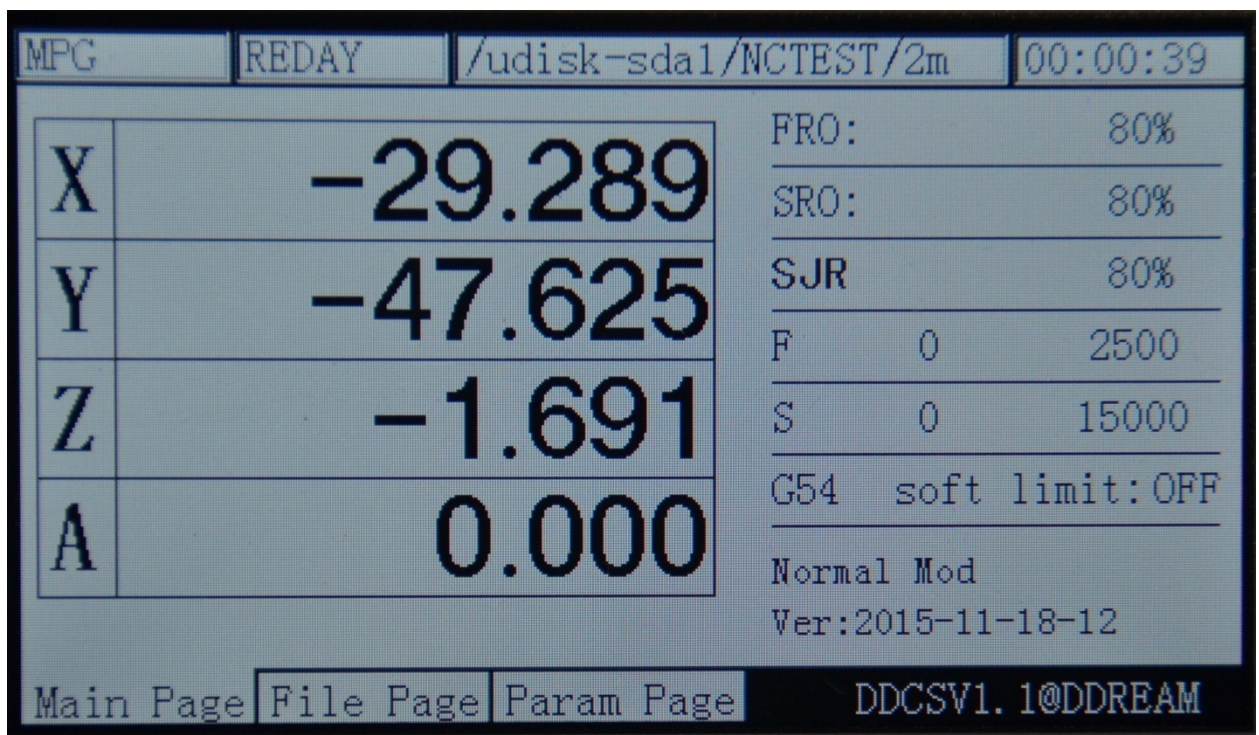

Picture3-32. "SJR" adjusts to 80%

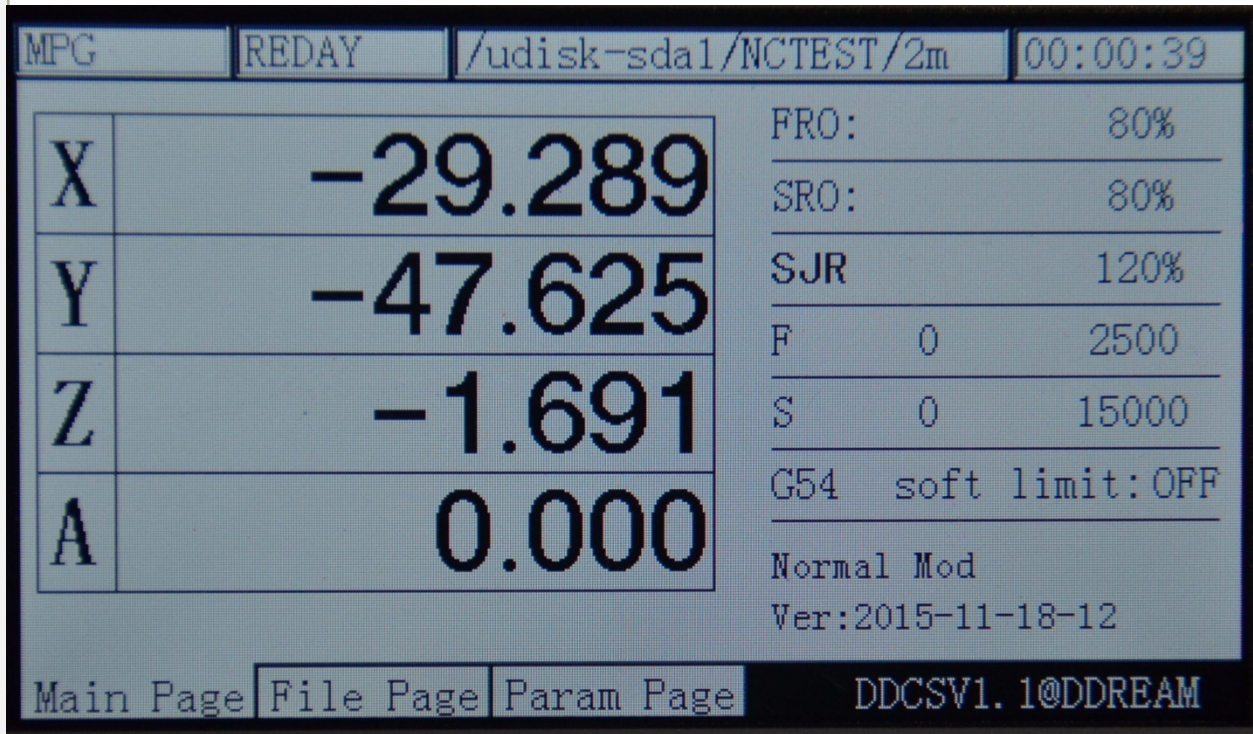

Picture3-33. "Manual control" adjusts to 120%

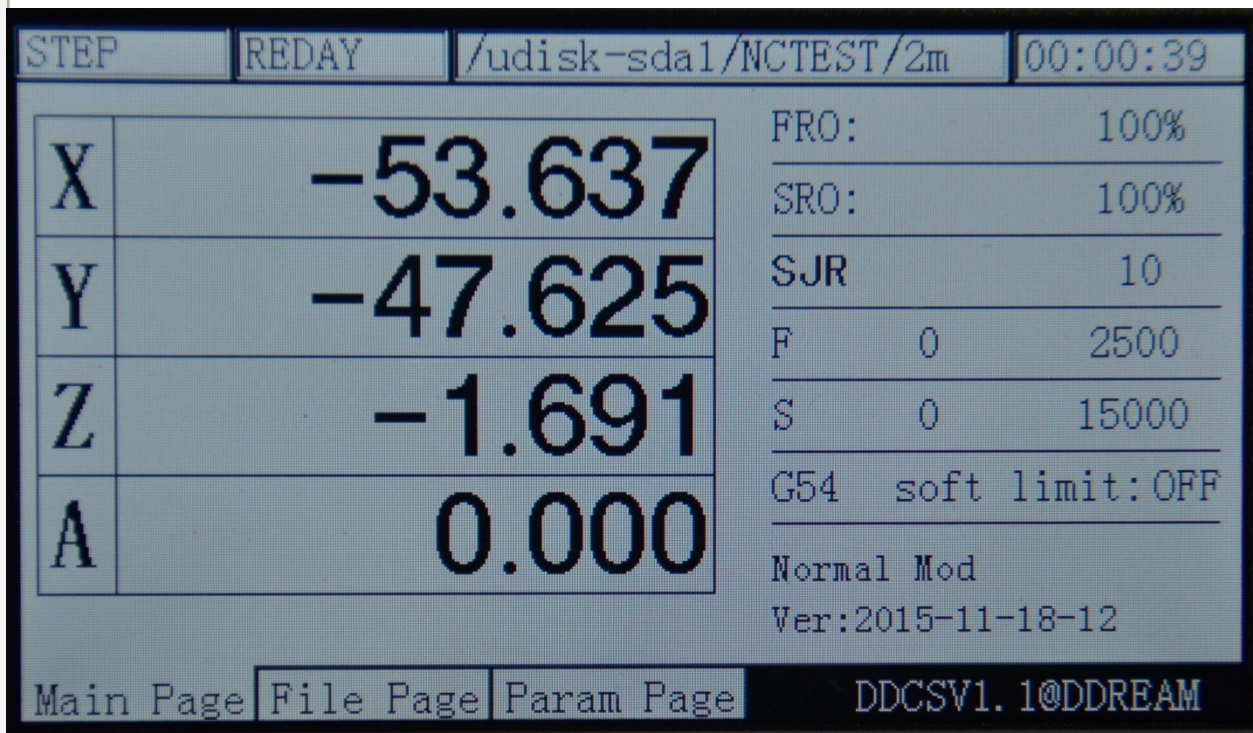

Picture3-34. SJR value adjusts to 10 under the mode of "step"

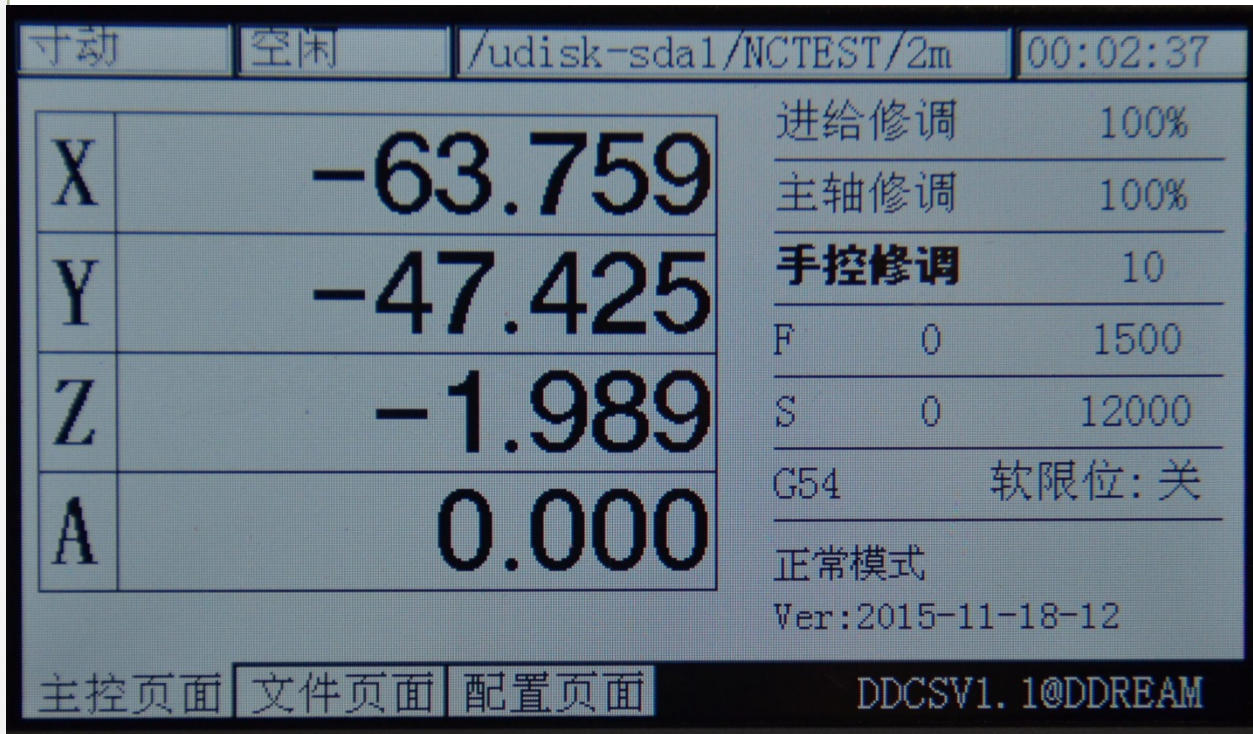

Picture3-35. SJR value adjusts to 10 under the mode of "step"

4) F Value modification

The F value adjustment is to adjust the default feed speed. Under the mode of

SJR adjustment; press  to enter the F mode. At this time, the word of F will change as the bold type, just as the Picture 3-36 shows:

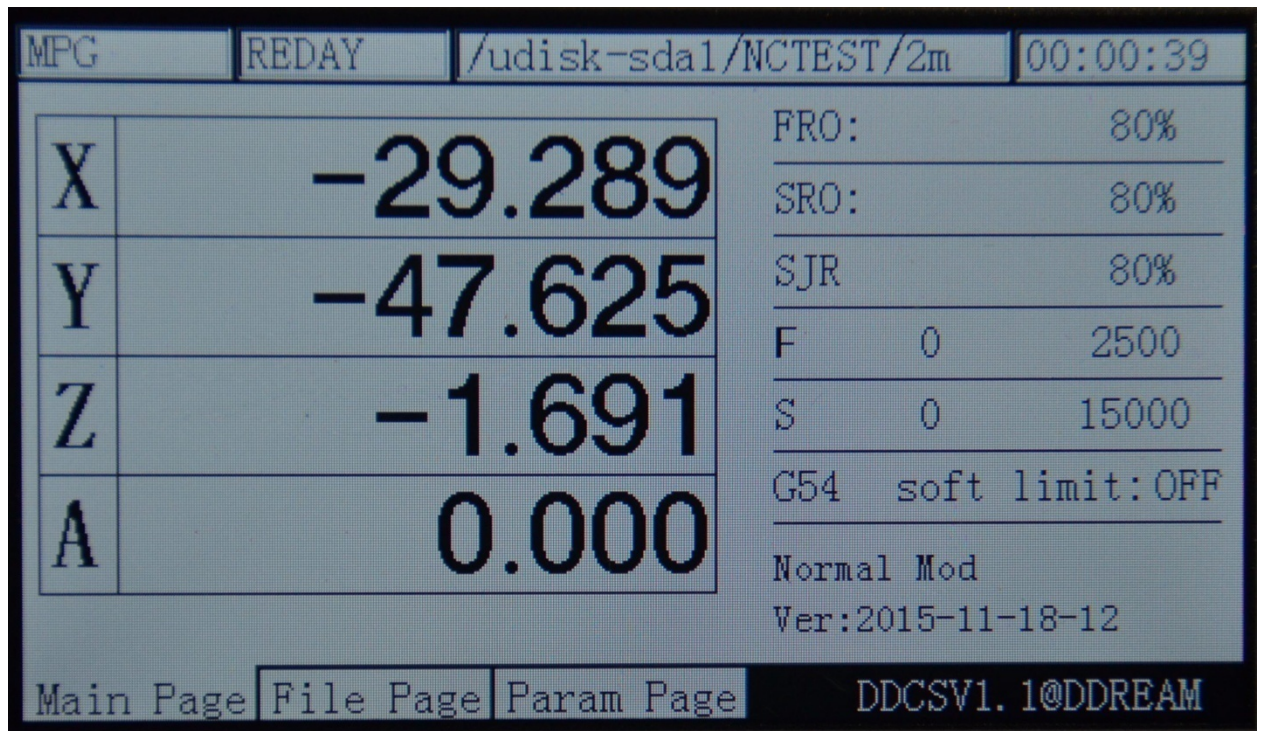

Picture3-36. Enter the F parameter modification mode



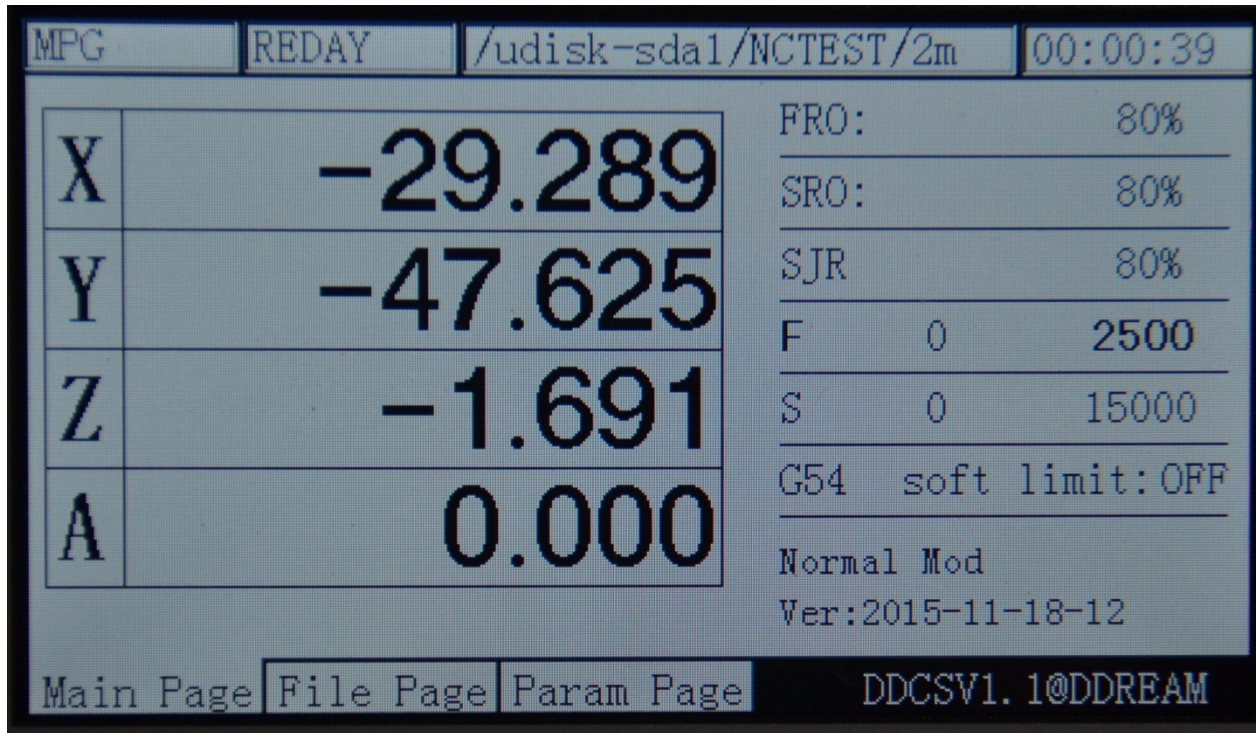

Under the F modification mode, press the key  to ensure whether use the default F as the current processing F. As the picture 3-36 shows, if the word, 2500 is not the bold type, the current F parameter takes G code as the standards. As the picture 3-37 shows, if the word, 2500 is the bold type, the current processing F parameter takes the default setting F value as the standard.



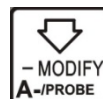

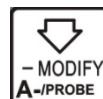
Picture3-37. Set the default F Value as the current processing F value

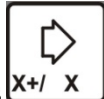

Under the F modification mode, press the key  to enter the default F value modification mode. At this time, the edit text will be popup. Please look at Picture 3-38 for reference, The prompt message section indicates the function of X+,X-,Y+,Y-,Z+,Z-. At this

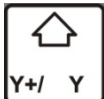
time, press  to move the cursor left one bit. Press  to move the cursor right

one bit. Press  , the cursor will assign the current bit value to be +1. Press  , the

cursor will assign the current bit value to be -1. Press  to cancel the current value

modification. Press  to enter the current value modification. As the picture 3-39 shows, the F value is modified as 2500. As the picture 3-40 shows, after entering the modification, the current default F value will change to 3500.

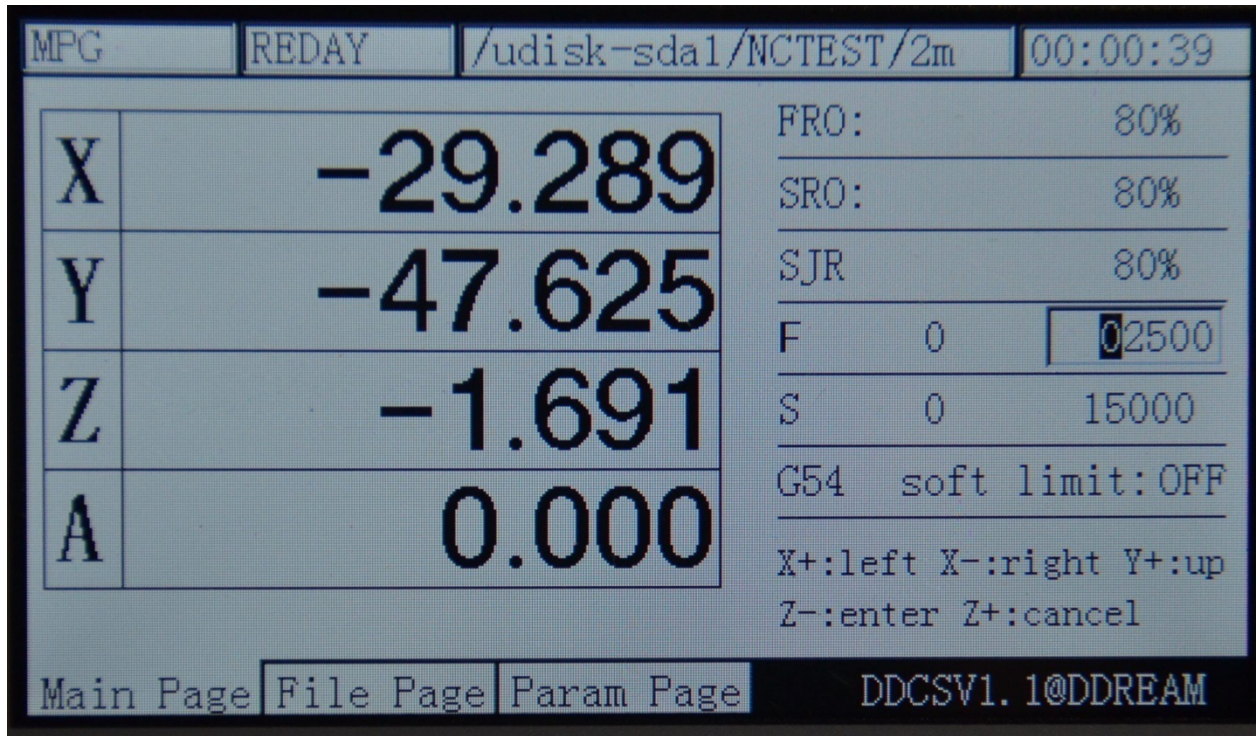

Picture3-38. Enter default F modification mode

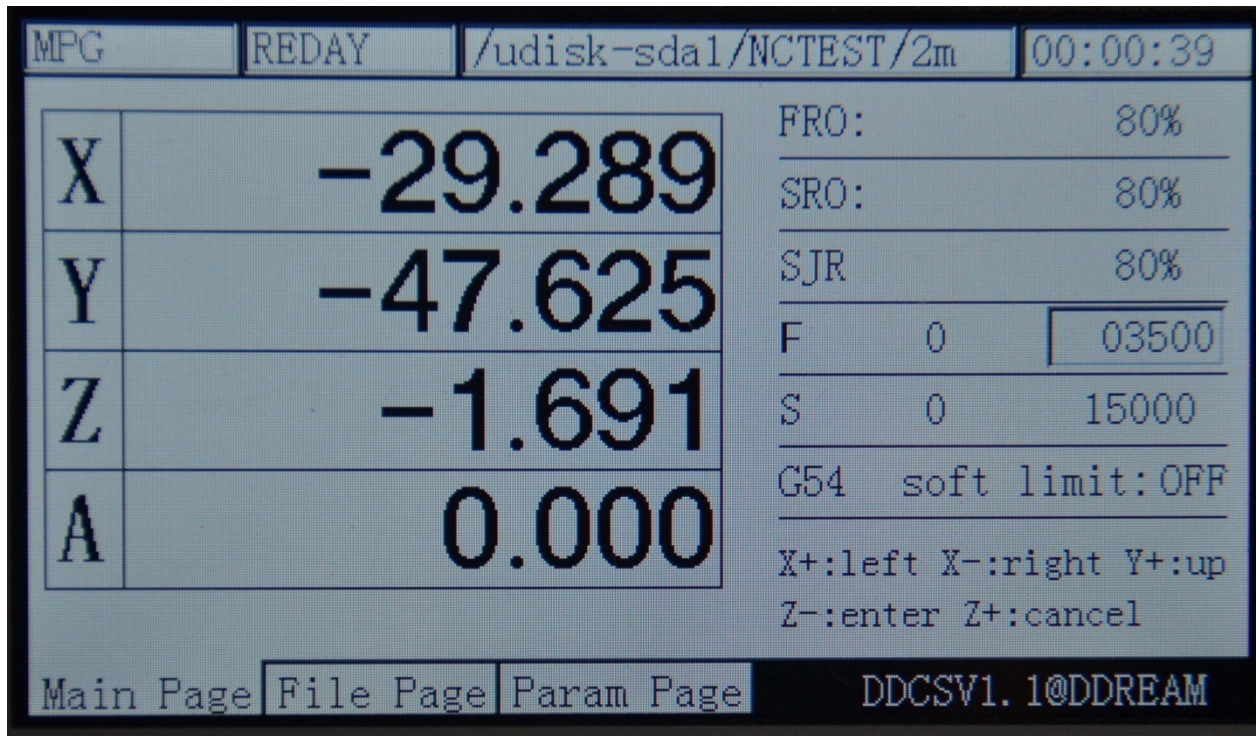

Picture3-39. UseX+X-Y+Y- to change the F value as 3500

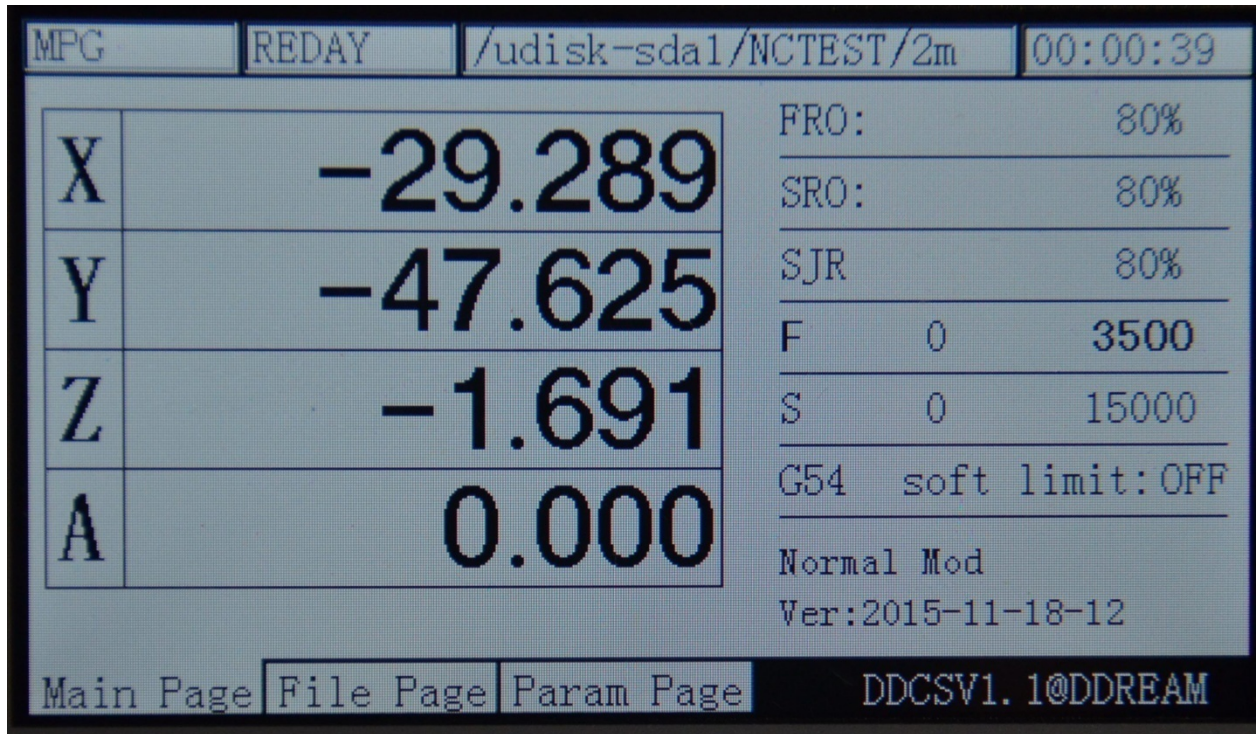

Picture3-40. Current F default value change to 3500 after entering

5) S Value modification

The S value adjustment is to adjust the default speed of spindle. Under the mode of F

adjustment, press  for one time to enter the F mode. At this time, the word, F will change as the bold type. Just as the Picture 3-41 shows:

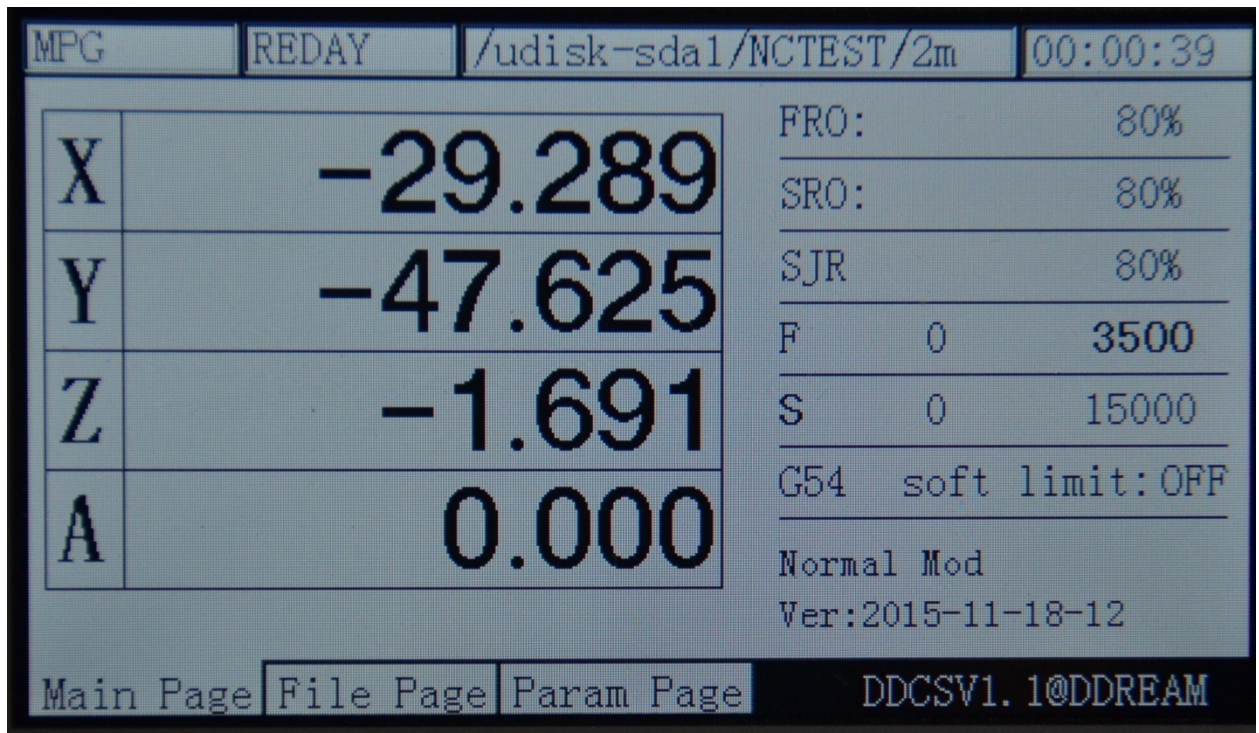





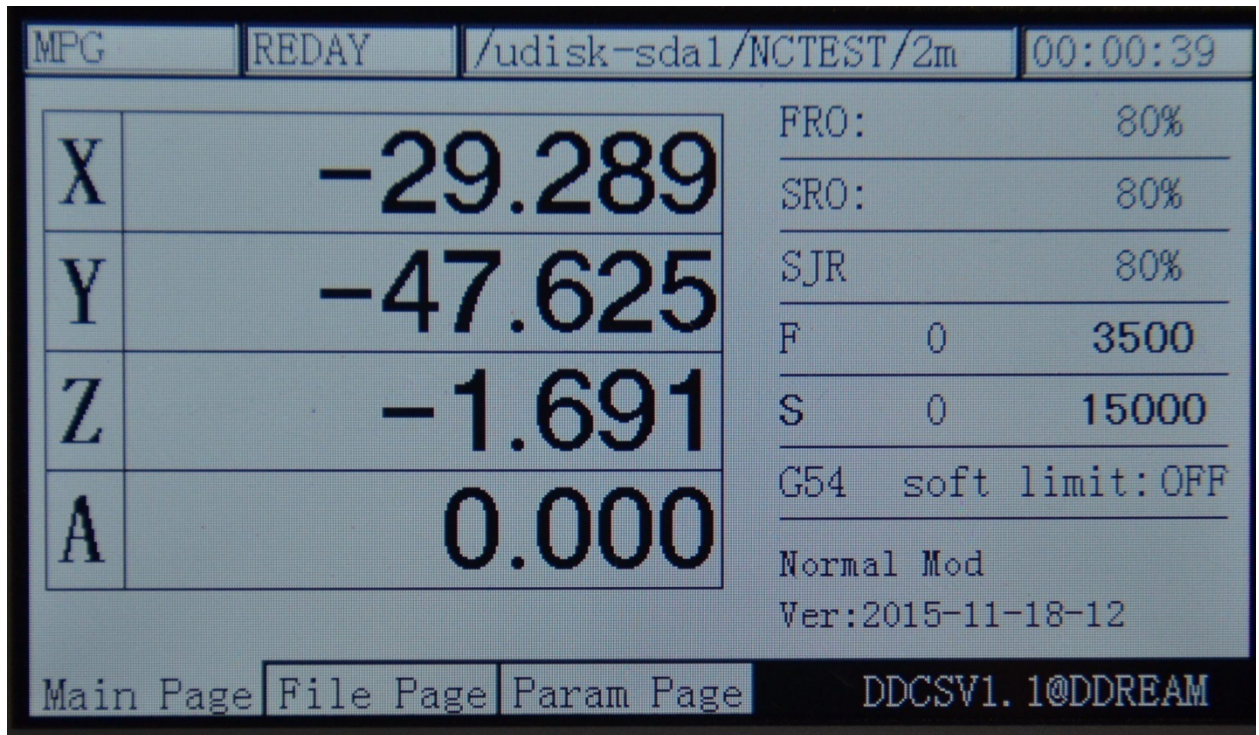

Picture3-41. Enter the S parameter modification mode

Under the mode of S modification, press the key  to ensure whether use default S

as the current processing S. As the picture3-41 shows, if the word, 15000 is not the bold type, the current processing F parameter takes the G code as the standard. As the picture 3-42 shows, if the word, 15000 is the bold type, the current processing F parameter takes the default setting F value as the standard.

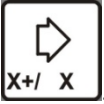
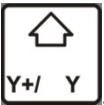

Picture3-42. Set the default S value as the current processing S value

Under the S modification mode, press the key  to enter the default S value modification mode. At this time, the edit text will be popped up, with the prompt message section indicating the function of X+,X-,Y+,Y-,Z+,Z-, Press the key  at this time, the cursor will move one bit left. Press the key  , the cursor will move one bit right. Press the key  , the cursor assign the current bit value to be +1. Press the key  , the cursor assign the current bit value to be -1, Press the key  to cancel the current value modification. Press the key  to enter the current value modification. The specific modification method can take the F default value modification steps for reference. As the picture 3-38 and picture 3-40 show:

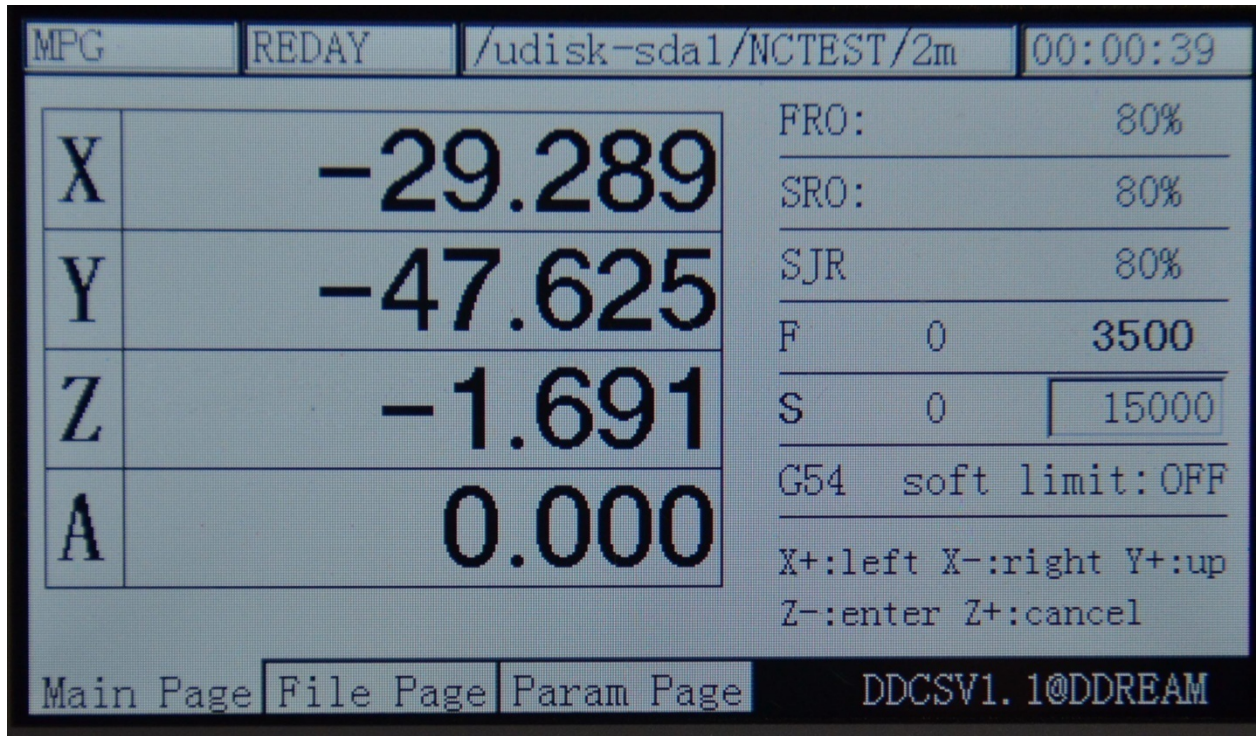

Picture3-43. Enter the status of modifying default S value

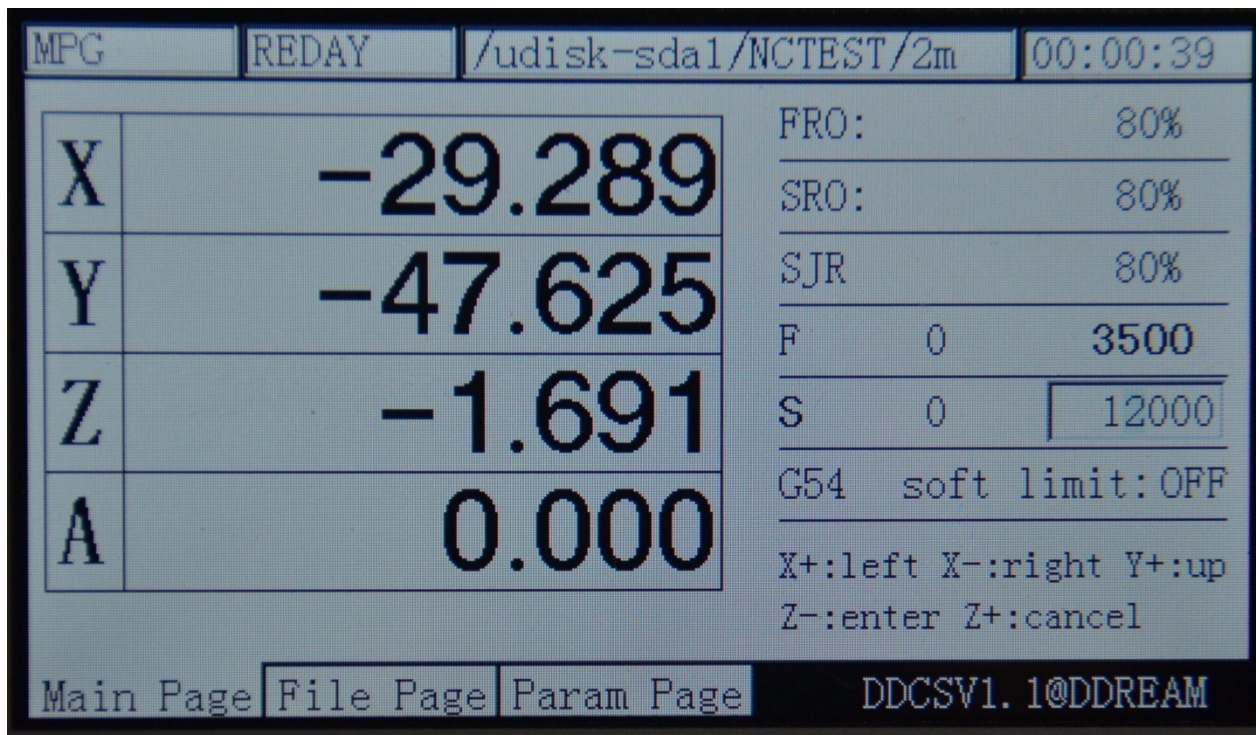



Picture3-44. Modify the default S value as 12000

6) Select G coordinate system

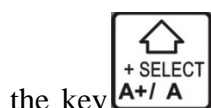

In the S modification mode, press the key  to enter the coordinate system mode. At this time, the coordinate system value will change to be the bold type. At this time, if you press

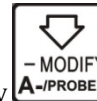

the key , the coordinate system value will increase. If you press the key , the

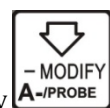

coordinate system value will decrease. The picture 3-45 shows that the current coordinate system is G 54 before modification. After pressing the key for two times, the picture 3-46 shows the current coordinate system is G56 after modification.

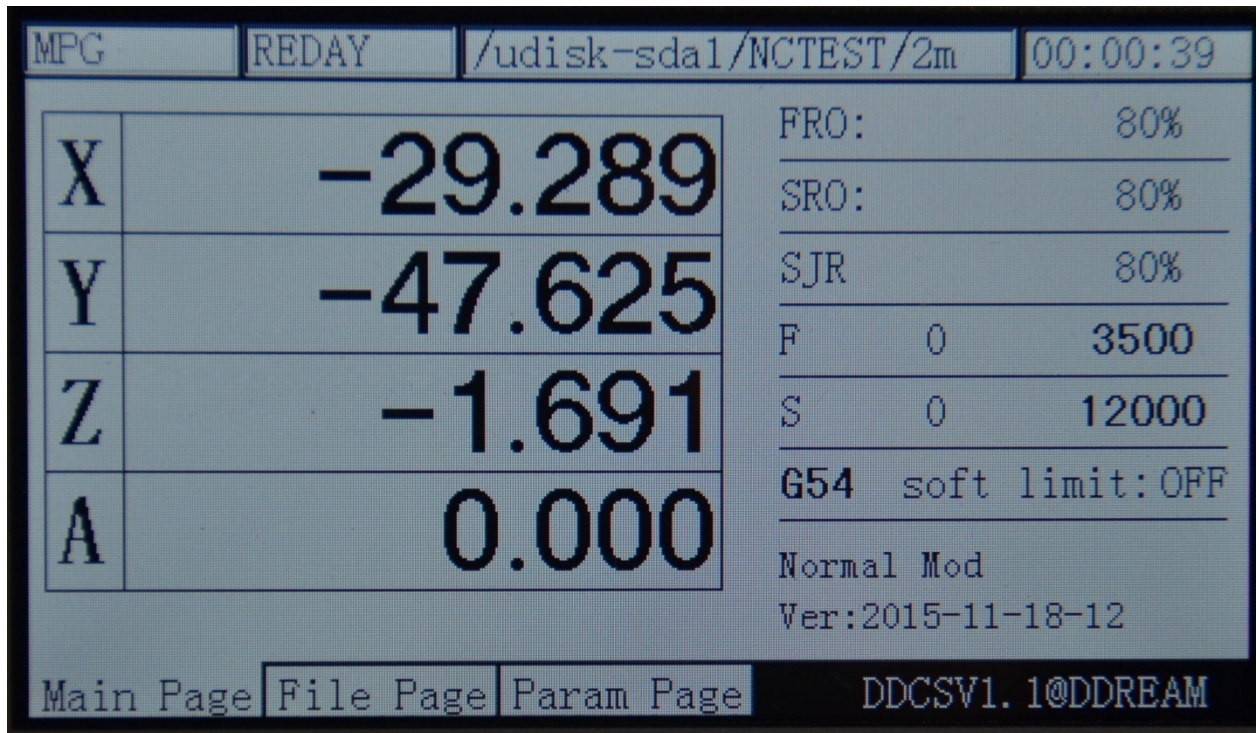

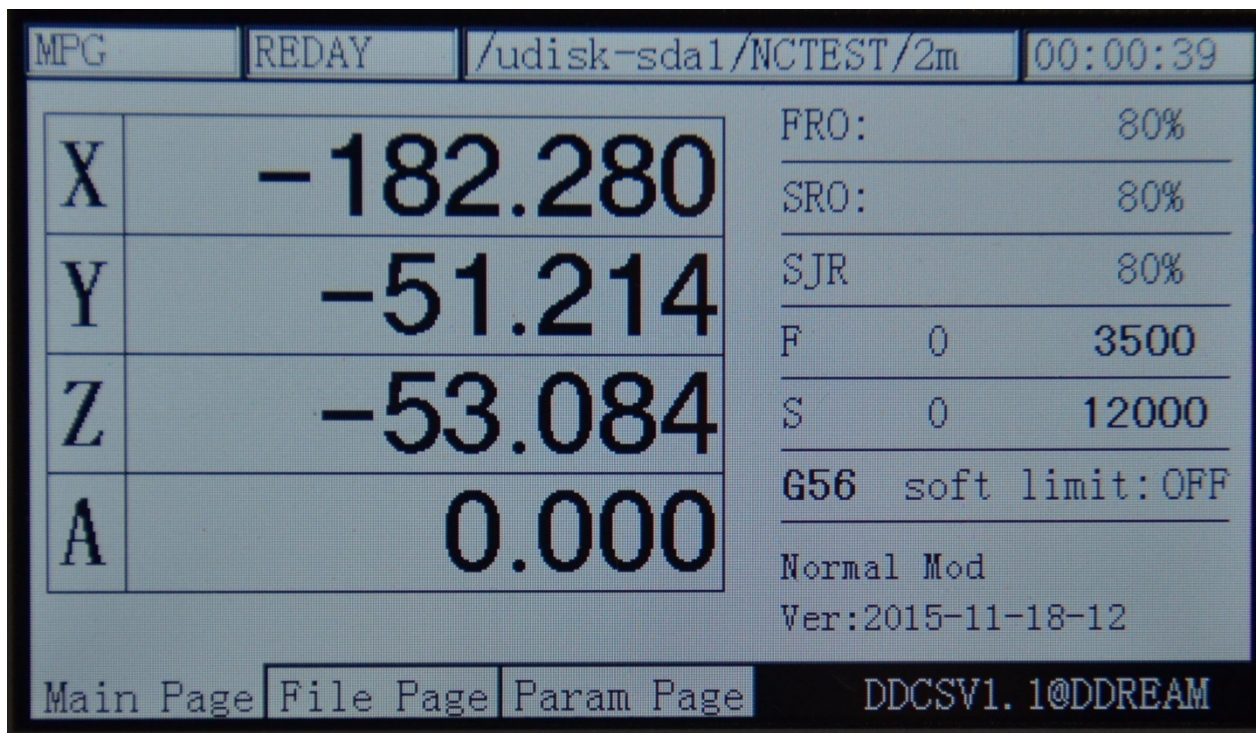

Picture3-45. Modify the current coordinate system as G54



Picture3-46. Modify the current coordinate system as G56

7)Soft limit switch

in the Select G coordinate system mode, press the key  to enter the soft limit

switch mode, show as picture 3-47. The soft limit switch is OFF. Press the key  to

change the OFF to ON, see as picture 3-48. If you want change it to OFF, press the key  again.

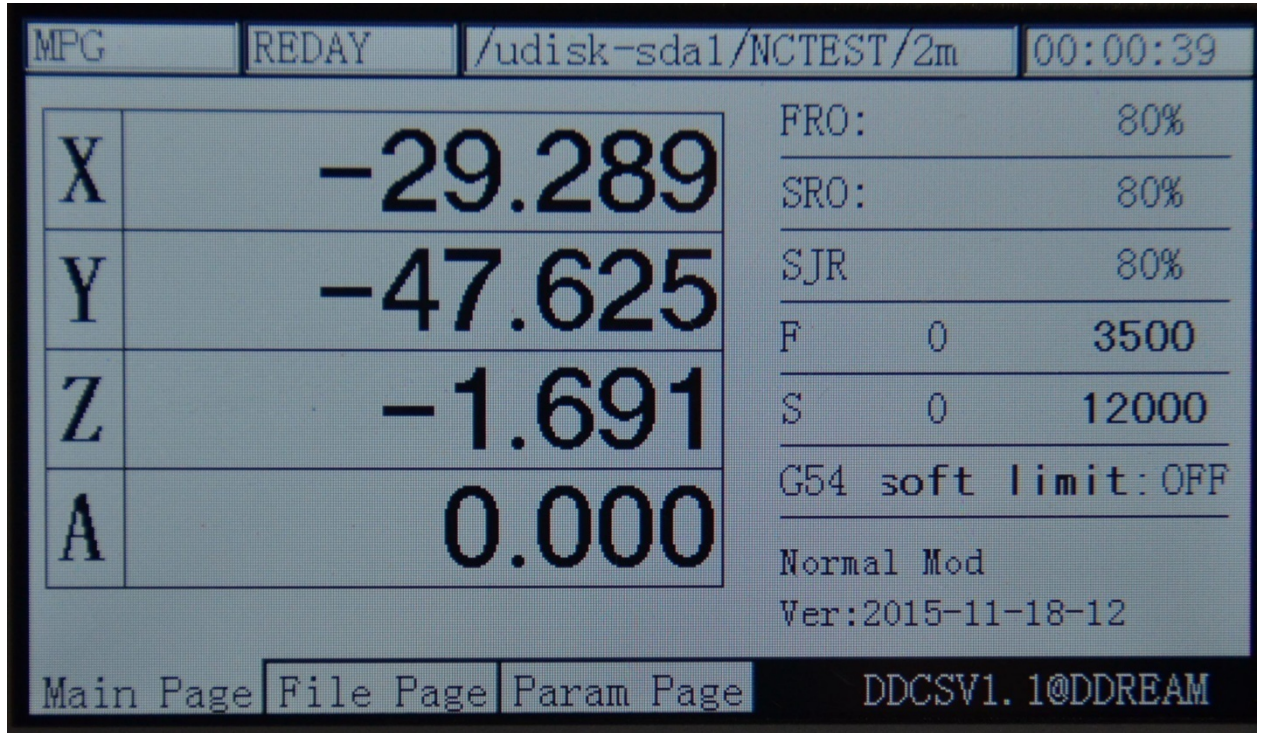

Picture3-47. Enter the soft limit switch mode, the soft limit is OFF at the time

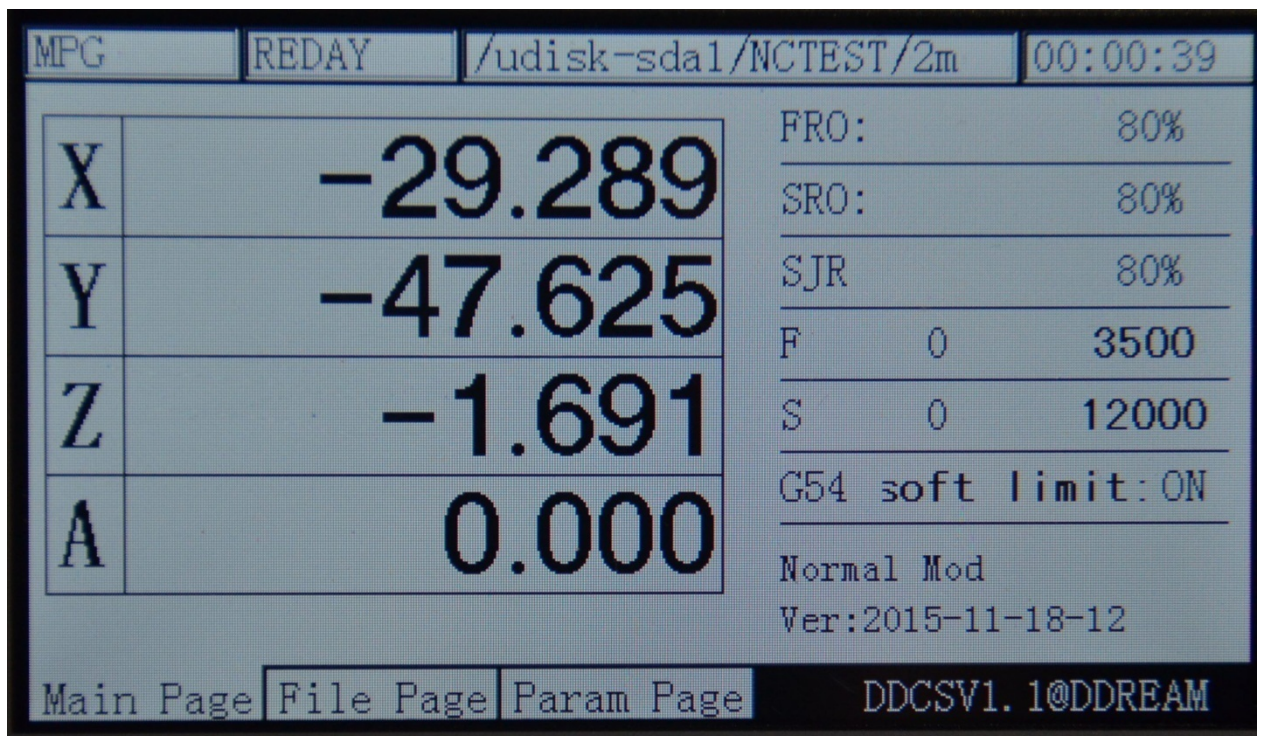

Picture3-48. set the soft limit to "ON"

3.3.5 The 2nd mode

The 2nd mode is some miscellaneous function except for the automatic processing, which includes the bank work piece 0-point, current coordinate setting 0, searching for the machinery coordinate 0-point and probe. When you need to use the 2nd function, please firstly press the



key to enter the 2nd mode and then conduct the other operations. In terms of the four 2nd modes, the specific operation methods are described in the following.

1) Back work piece 0-point

In the normal standby mode (the operation status column displays REDAY, the prompt



message column displays "normal mode", press the key to enter the 2nd mode. At this time, the prompt message column displays: X-:gotoz Y-:zero Z-: home A-:probe start:goto break and the feed status column displays "2nd mode", as the picture 3-49 show. Press the key



once again; it will enter the goto zero mode, as the picture 3-50 shows.

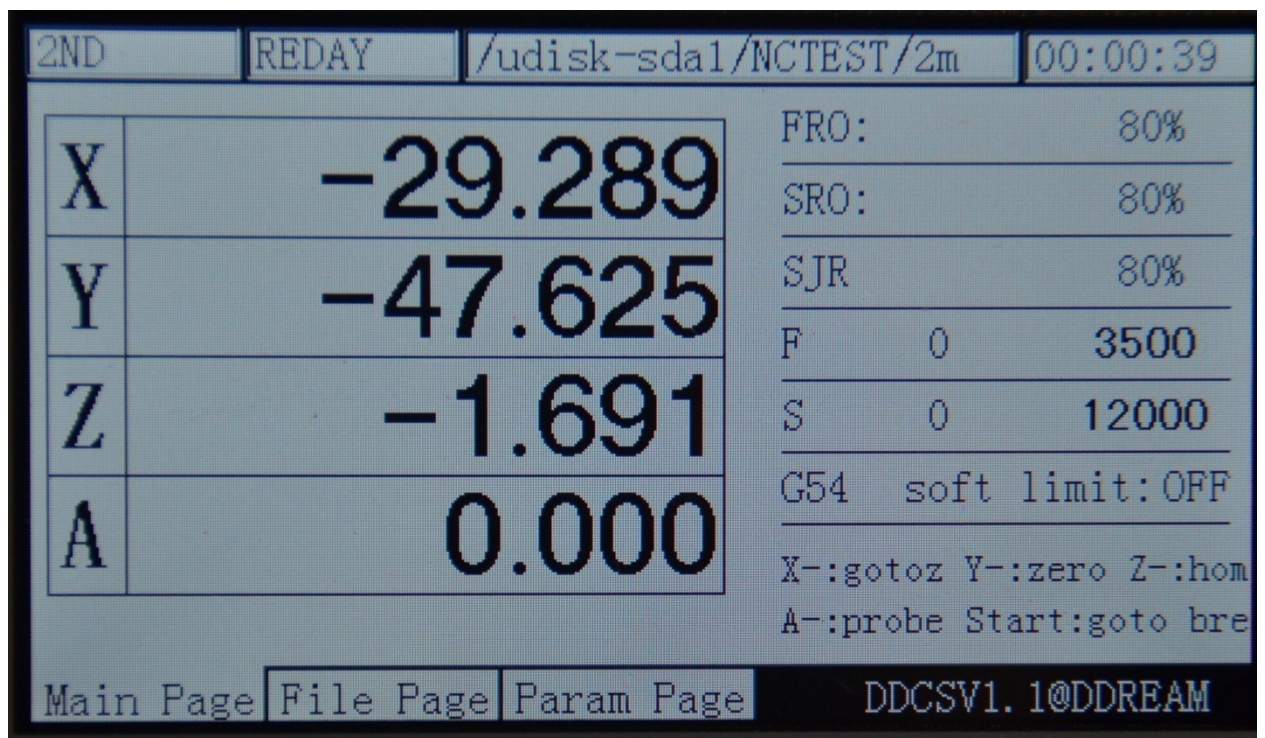

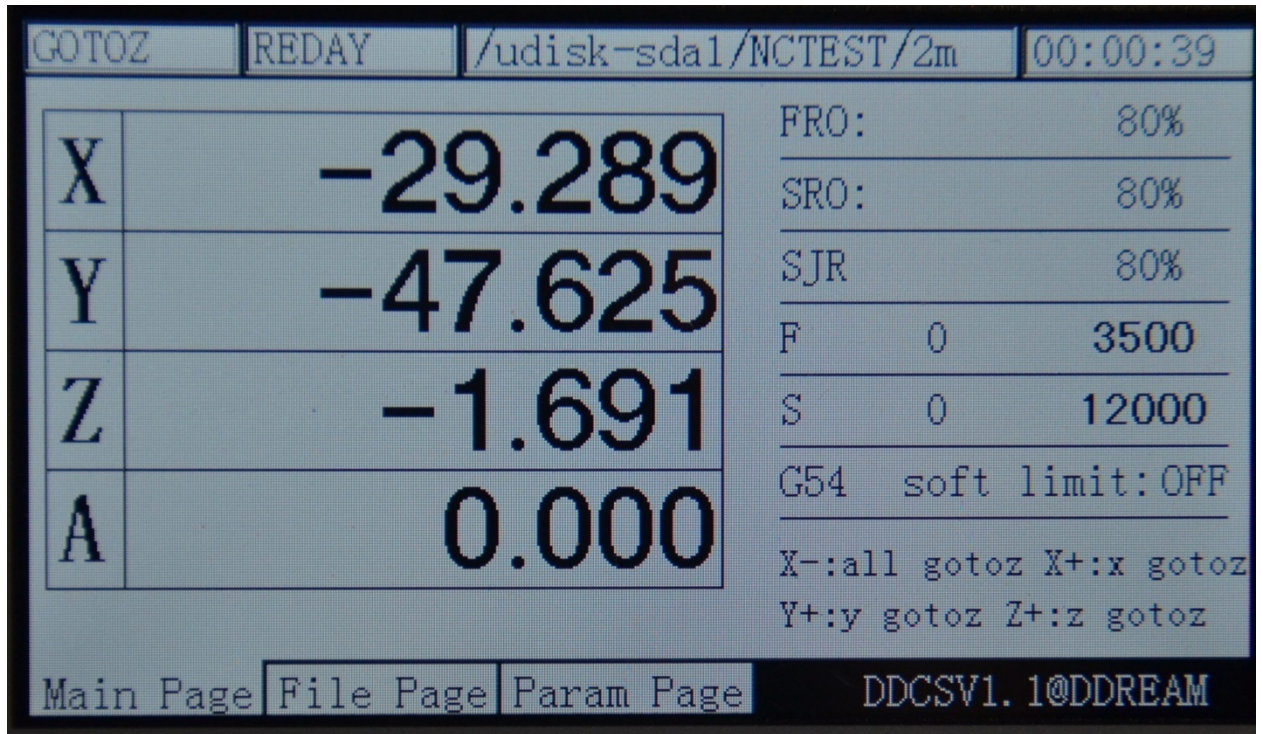

Picture3-49. Enter the "2ndfunction" mode



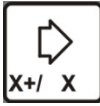
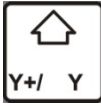

Picture3-50. Enter the “Gotoz” mode

In the “gotoz” mode, two modes can be entered:

A: in the “gotoz” mode, if you press the key  once again, all the back work pieces of all the axes are at 0-point. At this time, in order to protect the spindle, the system will make the 3 axes of X, Y, A to operate firstly and then operate Z axis to the 0-point. If the coordinate of the Z axis is less than 5, the system will lift the Z axis to the 5 position and then operate other axes. Finally, the Z axis will be gotoz.

B: In the mode of “gotoz”, press  or  or  or  to start the 1 axis of X, Y, Z, A gotoz or operate to designated coordinate function. Here let's take the X axis

as an example. When you press the key , the feed status column also displays the “gotoz” at this time and the prompt message column displays: X+:left X-:right Y+: up Y-:

down Z-: enter Z+: cancel. At this time, if you directly press , the X axis will gotoz. If

you press  after setting the specific coordinate value by separating these keys in accordance with the prompt messages, the X axis will operate to this specific coordinate. As the picture 3-51 shows, it sets the coordinate as 10. As the picture 3-52 shows, after pressing

the key , the X axis will operate to the position of 10.

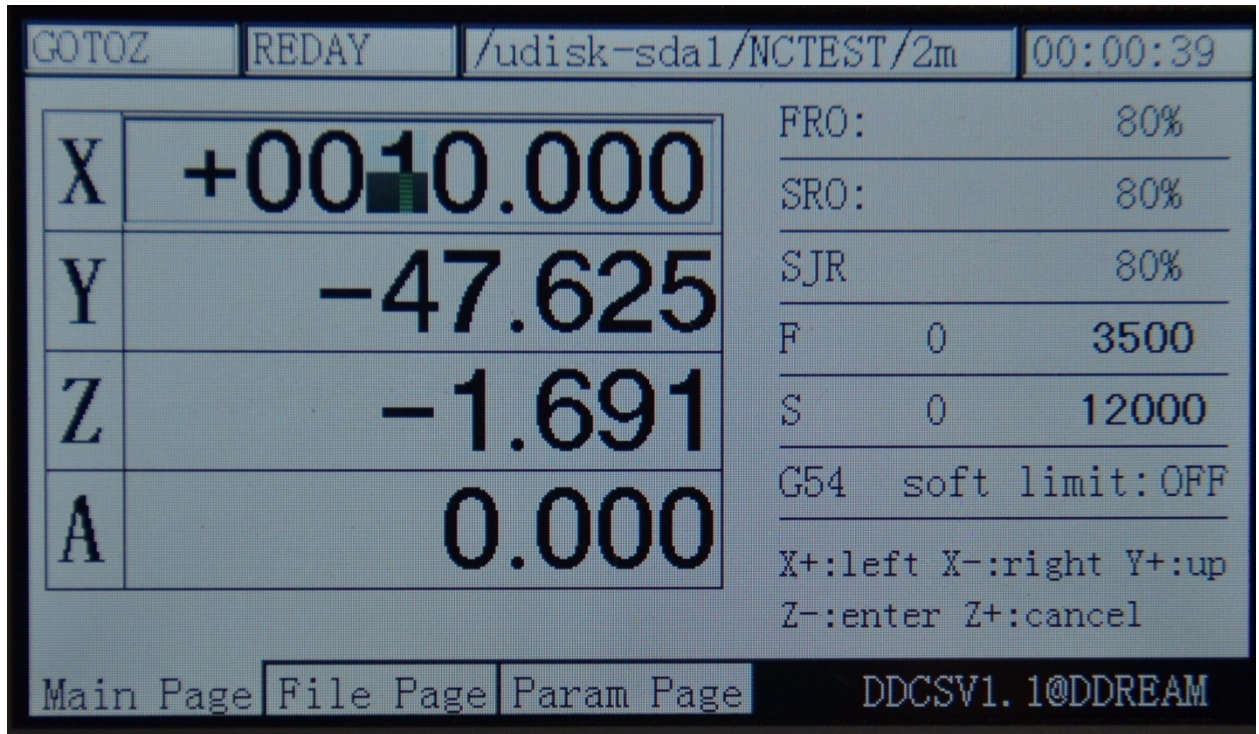

Picture3-51. Set the X target coordinates as 10

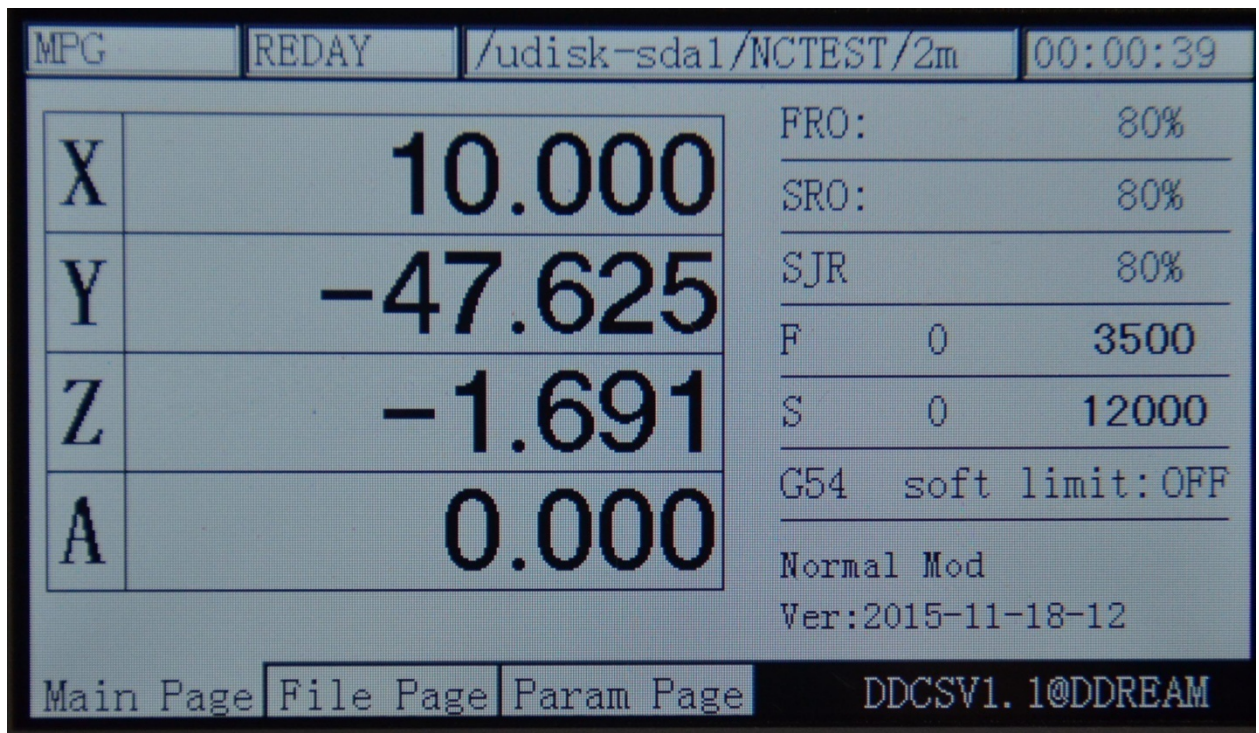

Picture3-52. After pressing the key , the X axis will operate to the position of 10.000

2) Set the current coordinate to 0

In the normal standby status (the operation status column displays “REDAY” and the prompt message column displays “normal mode”), press the key  to enter the 2nd mode. At this time, the prompt message column will display: X-:gotoz Y-: set the 0 Z-: home

A-:probstart:goto break。 The feed status column will display “the 2nd mode”, as the picture

3-49shows. Press the key  once again to enter the current coordinate 0-clearing mode.

At this time, the feed status column displays “zero”, as the picture 3-53shows.

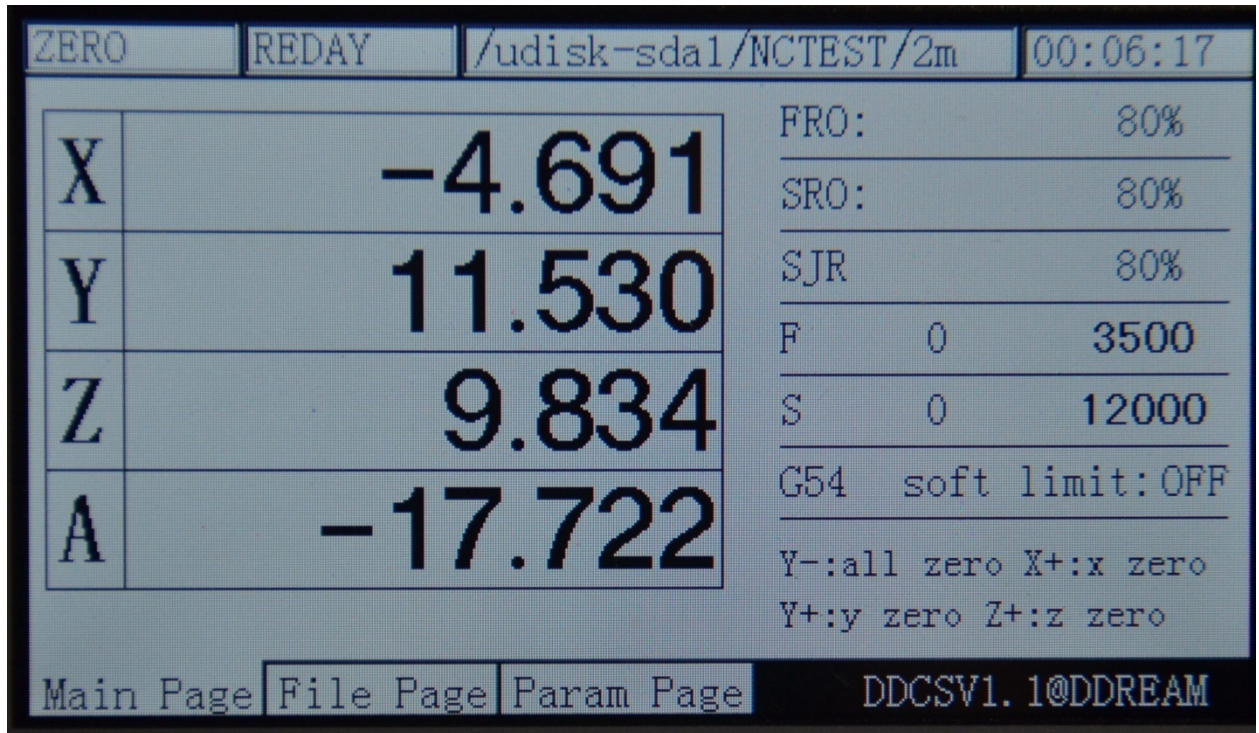



Picture3-53. Enter the “zero” mode

In the “zero” mode, 2 modes can be entered:

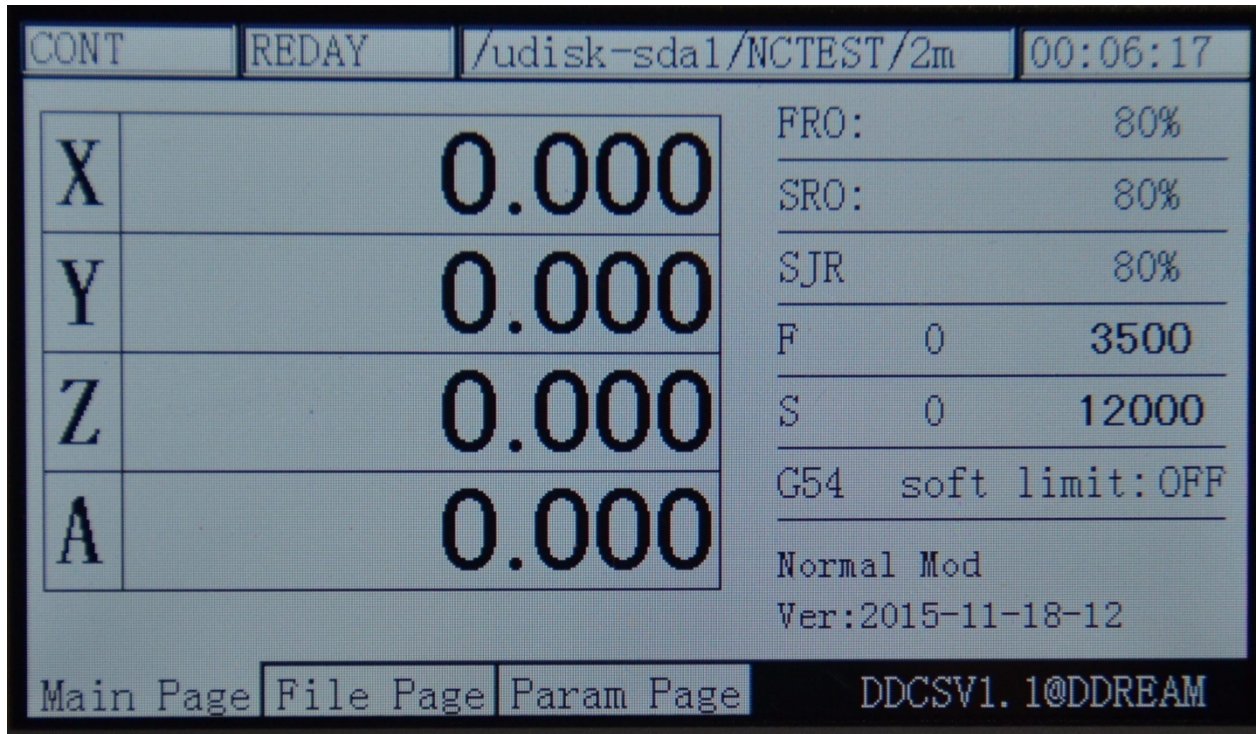

A: In the “Ten” mode, when you press the key  once again, all the current coordinate will be 0-clearing and then it will quit the “2nd mode” mode and go back the “REDAY” status, as the picture 3-54 shows.

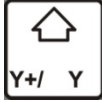

Picture3-54. All the current coordinate be 0-clearing

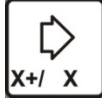
B: in the “zero” mode, press  or  or  or  to start the 1 axis of X,Y,Z,A to be 0-clearing or modify it as the designated coordinate value function. Here let's

take the X axis as an example. Press the key  to start the function of X axis 0-clearing. At this time , the feed status column also displays “the 2nd mode” and the prompt message column displays: X+: left X-:right Y+: up Y-: down Z-: enter Z+: cancel. At this time, if you

directly press the key , the X axis will be 0-clearing. If you press  after setting the specific coordinate value by separating these keys in accordance with the prompt messages, the X axis will operate to this specific coordinate. As the picture 3-46 shows, it sets the

coordinate as 20. As the picture 3-55 shows, after pressing , the X axis coordinate will change to 20 and then quit to the function of “zero”. At this time, the X axis will not do the real movement.

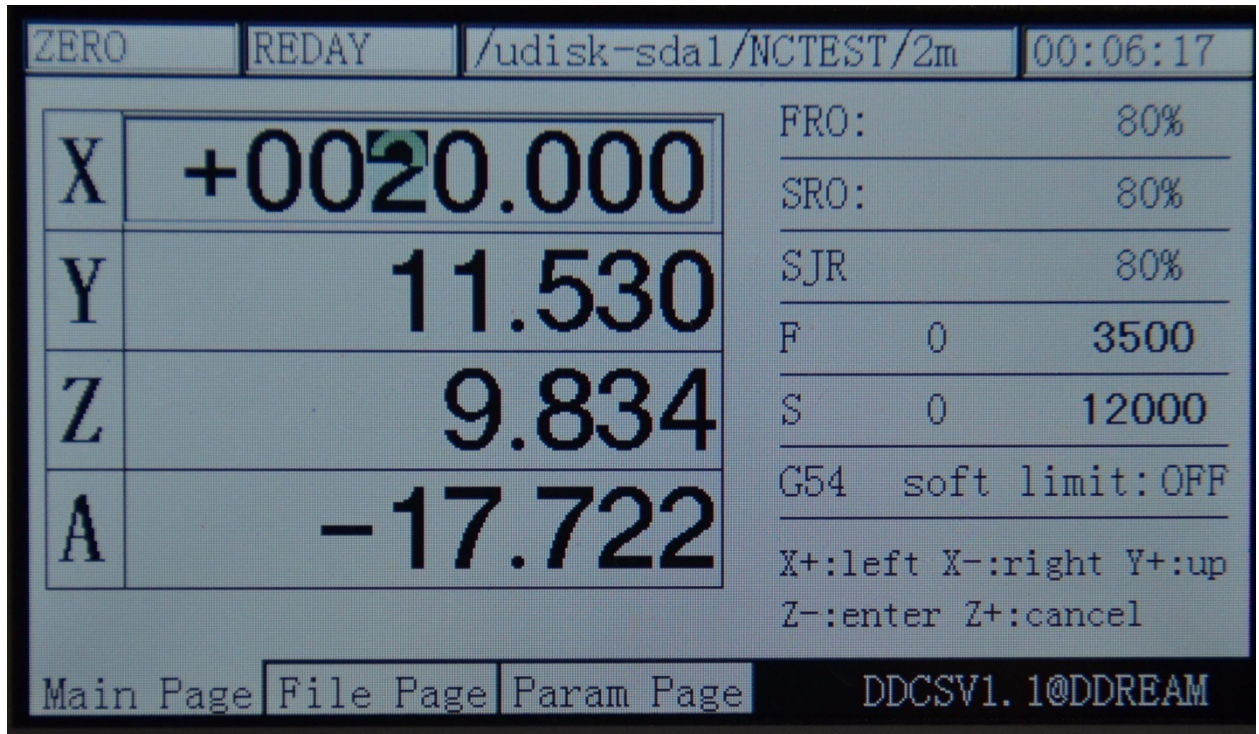

Picture3-55. The current X coordinate sets to 20

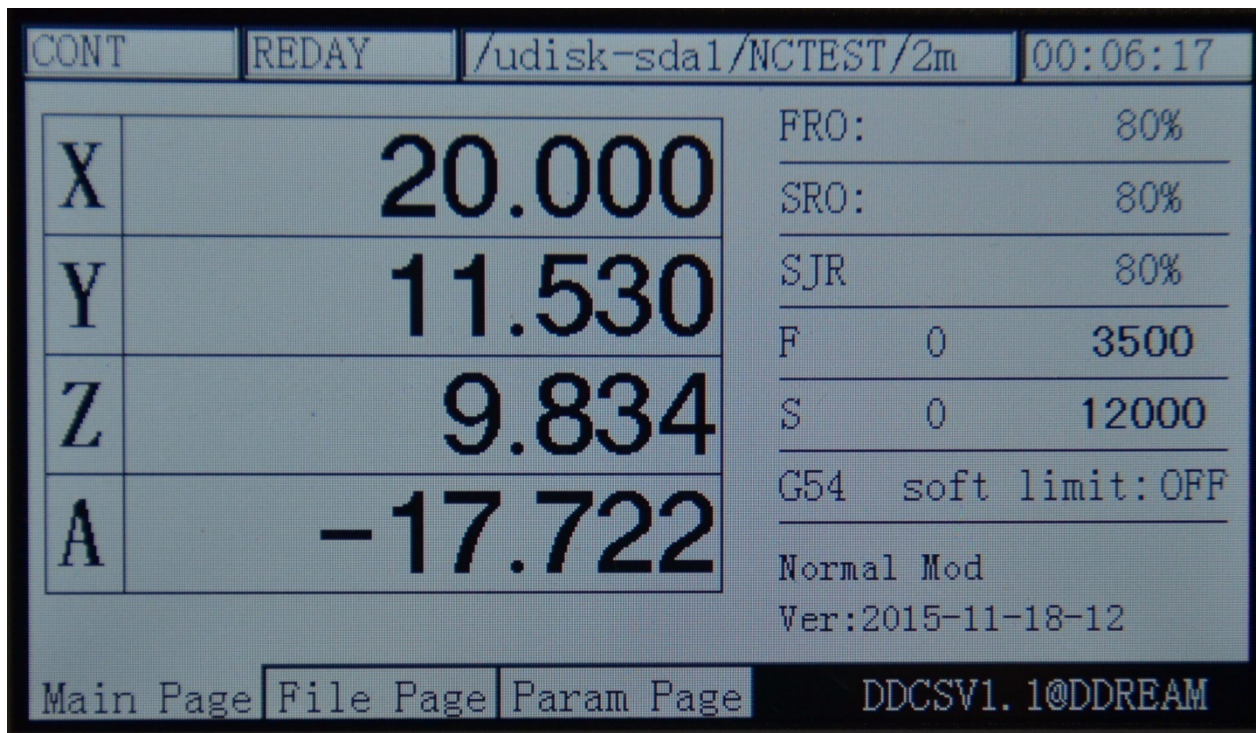

Picture3-56. After entering, the X coordinate change to 20

3) Home

In the normal standby mode, (the operation status column displays “REDAY” and the prompt message column displays “normal mode”), press the key  to enter the 2nd mode. At this time, the prompt message column displays: X-:gotozY-: zero Z-: home A-:probstart:

goto break. The feed status column displays “the2nd mode”, as the picture 3-57 shows. Press



the key  once again to enter the searching for the machinery 0-point mode. At this time, the feed status column displays “home”, as the picture 3-58 shows.

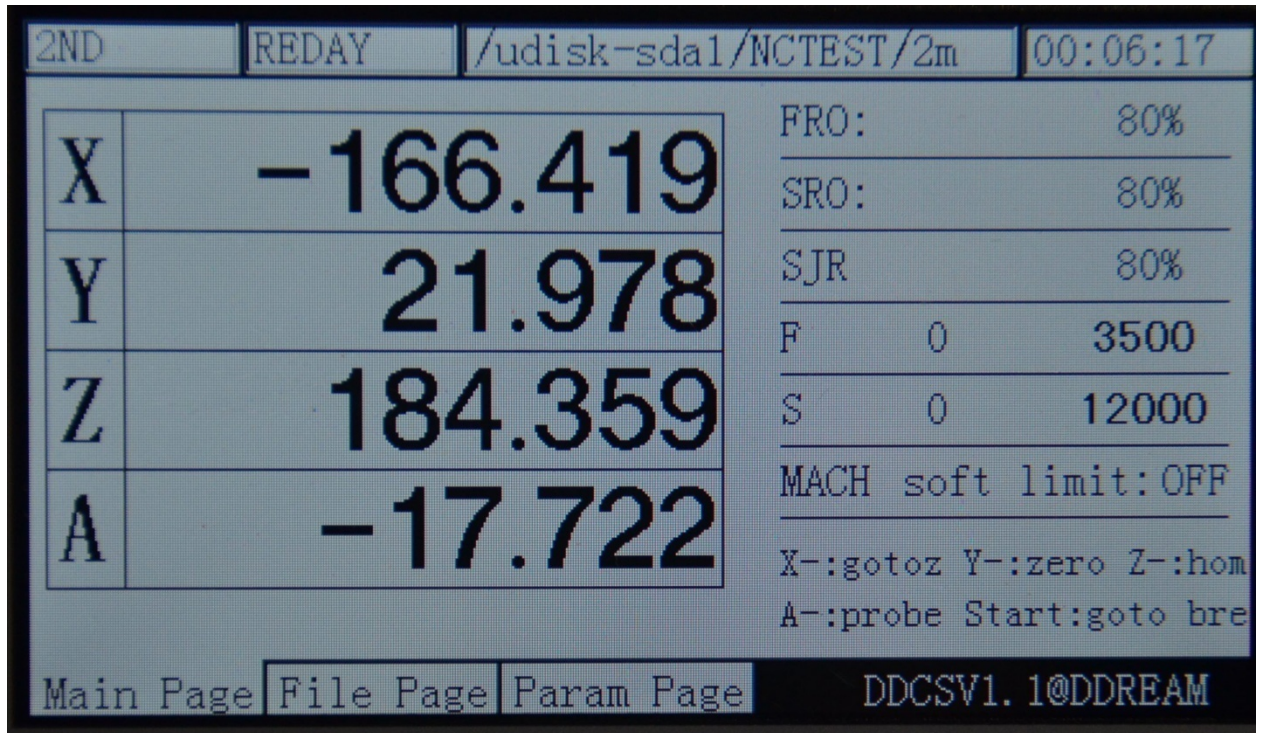

Picture3-57. Enter the “2nd mode”

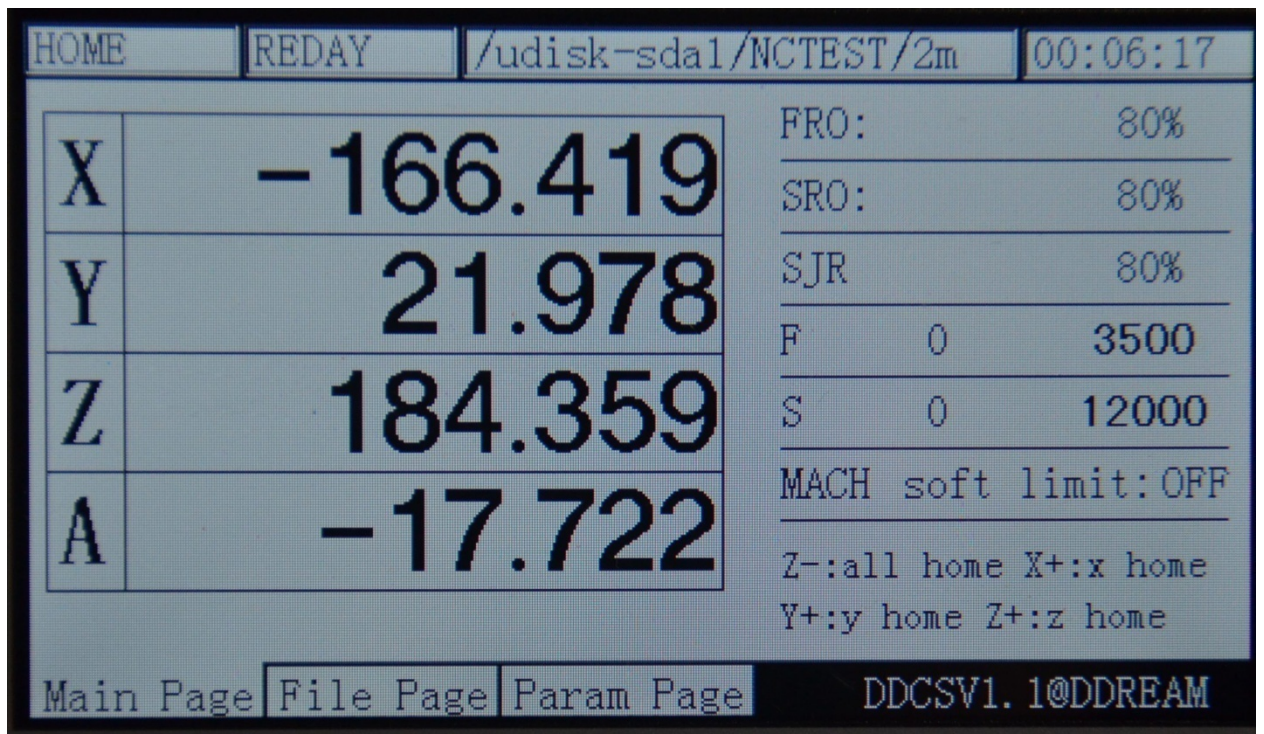

Picture3-58. Enter “home” mode



A: in the “ home” mode, press once again to start all the axles to entirely start the

home function. The order of searching for 0 is Z/X/Y/A. Under the situation of no A axis, the order is Z/X/Y.

B: in the “searching for 0” mode, pressing the corresponding axis to select the keys can start the 1 axis searching for machinery 0-point function. Here let’s take the X axis as an

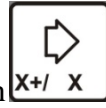

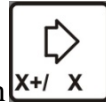
example. If you press the X axis to select the button , the X axis will maintain to move in the negative direction until it tests the close of 0-point switch and then it will stop decreasing speed and finally go back to the off-position of 0-point switch. The X axis of machine tool is set as 0 and then it will move the safety distance of 10mm in the positive direction, thus the whole X axis searching for 0-point function being end. Note: at this time, the end X axis, 146.375 is the work piece coordinate. At this time, the machinery coordinate should be 10. It needs to examine the machinery coordinate and please switch the coordinate system to MACH gear. Please look at the Picture 3-59 in detail for reference.

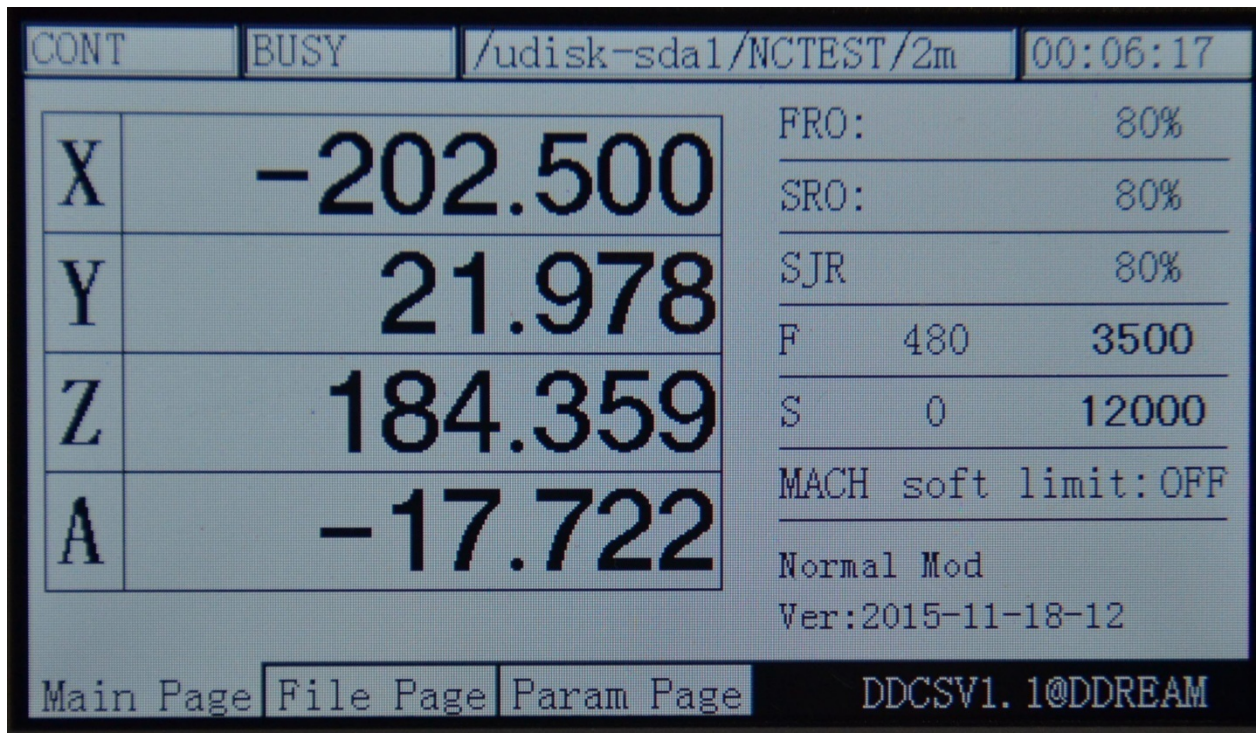

Picture3-59. Process of 1 axis of X axis home

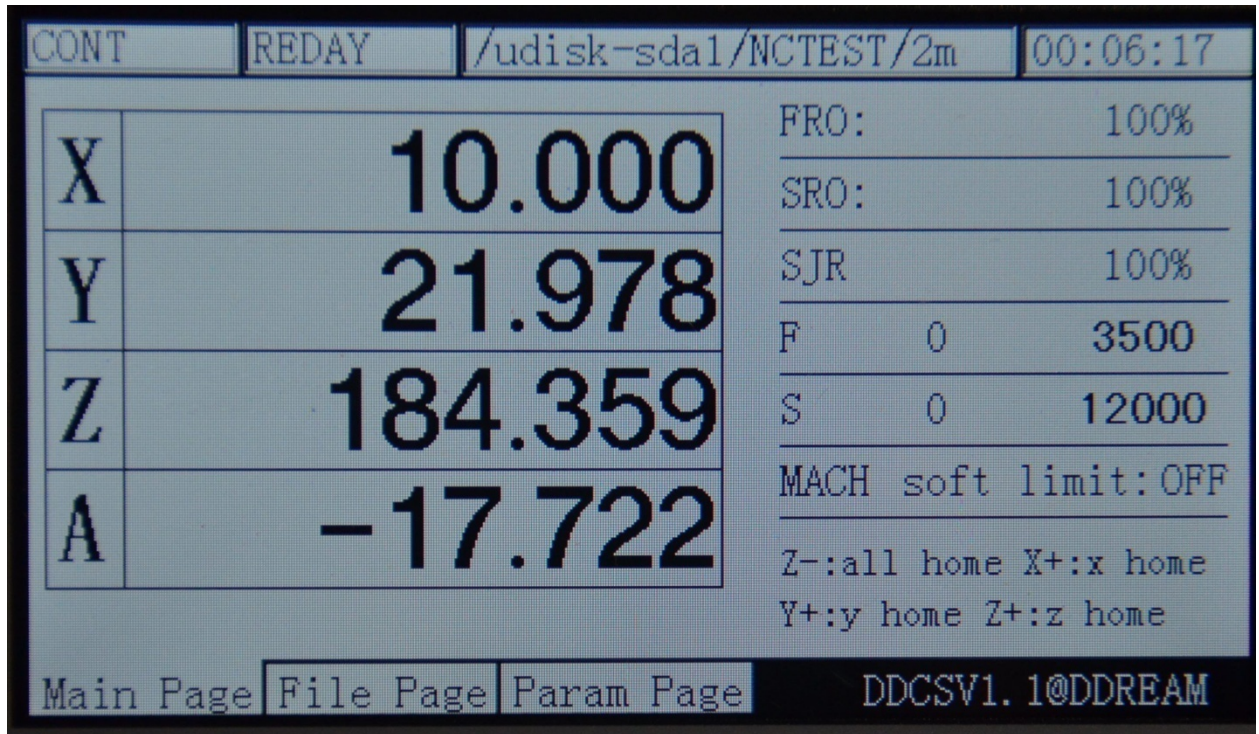

Picture3-60. the end of X axis' home



In the “searching for 0” mode, if you press  once again, the mode of holoaxial searching for 0 will be started. As for the operation methods, please look at the single-axis searching 0 for reference. The mode of holoaxial searching for 0 is to automatically switch to the next axis to search 0 at the end of the mode of holoaxial home. The order of holoaxial searching for 0 is X,Y,Z,A. As for the end of home, please look at Picture 3-61 for reference.

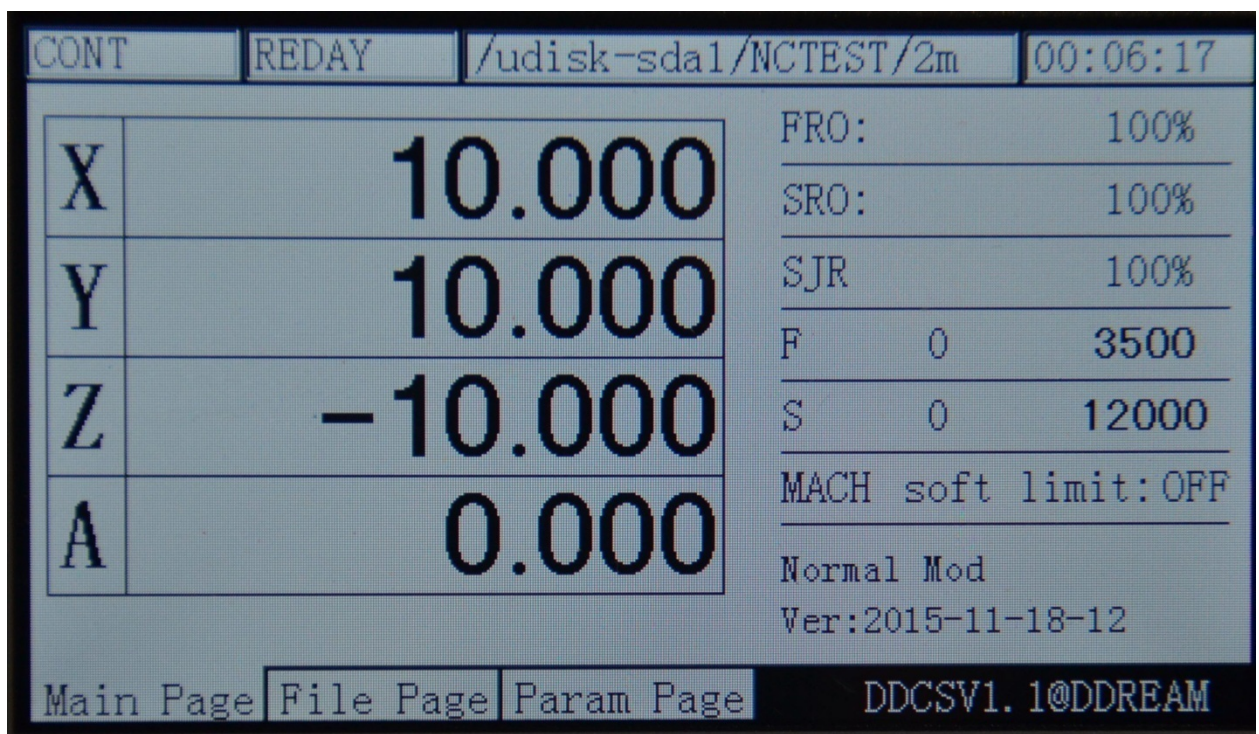

Picture3-61. The end of holoaxial home

At this time, we can switch the coordinate system to the MACH gear so as to examine the

machinery coordinate system of the equipment. Please look at the picture 3-62 for reference.

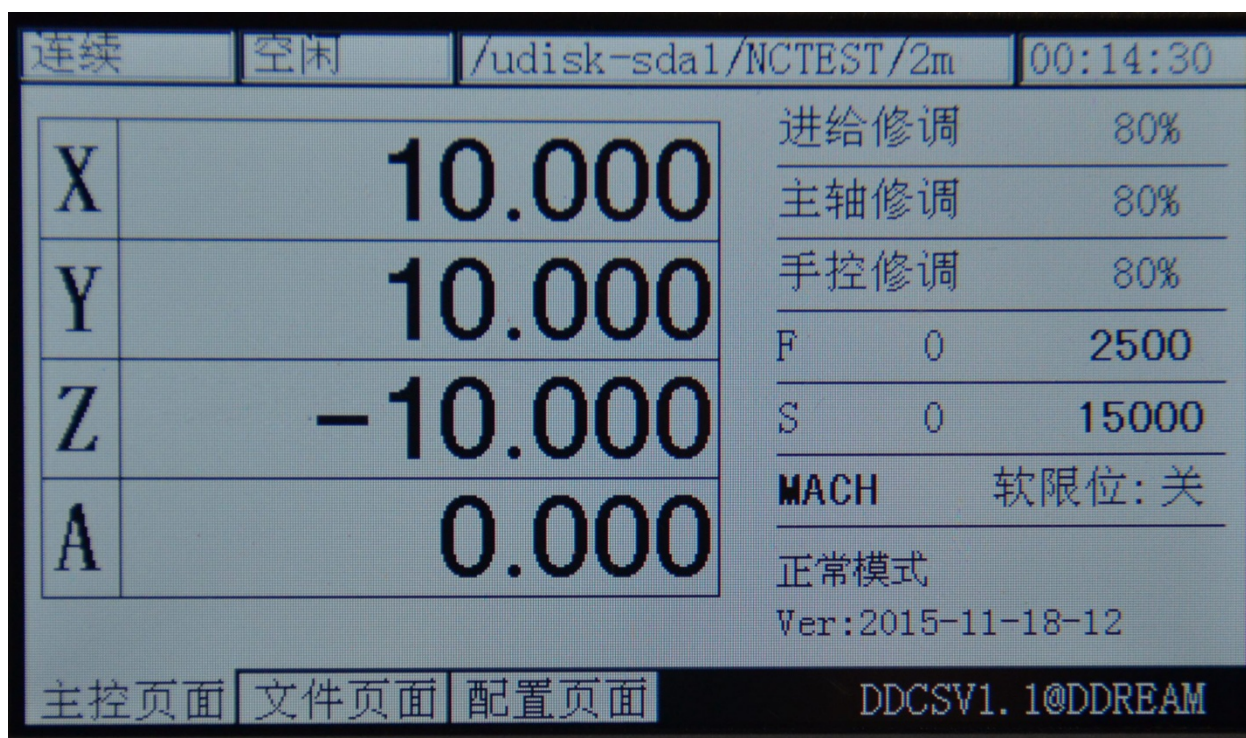

Picture3-62. Switch to the machinery coordinate system

4) Probe

Using the tool for a long time will make the tool be in abrasion. Or when you change the tool, the position relation between tool nose and electrical machine will be changed, thus directly causing that the direct processing influences the processing quality of work pieces. Under this situation, it needs to do the probe to ensure the excursion of new tool nose. In the system of DDCSV2.1, it adopts the mode of the fixed-point probe. This mode doesn't need the user to input the thickness of tools. The tools are put on the processing working table, which is convenient and efficient.

In the DDCSV2.1 system, the soft will record a virtual thickness of tools. What the parameter records is the distance between the work piece surface and the surface of tools. When this parameter conducts the 0-clearing action in the coordinate, (ensure the coordinate of new work piece), it will automatically clear this parameter. If the user needs to use the probe function, the user must do the probe operation once after the coordinate is 0-clearing. The probe operation of this time will modify the thickness parameter of the tools. Later, when you change the tool or when the tool is in abrasion, please do the probe operation again, thus the tool nose excursion being amended.

In brief, the probe operation totally contains 3 operations, including the coordinate 0-clearing, firstly probe, and change the tool or the second probe after ensuring the tool is in abrasion.

The specific operations are as follows:

a、 Firstly use the MPG or the mode of step / CONT to move the position of XYZ, and move the tool nose to the 0-point of the work piece, as the picture 3-63 shows.

b. Use the 0-learning function to make each coordinate of XYZA be 0-clearing.

c. First probe (records the thickness of the virtual tools), and if the probe selects “probe of current point”, you should firstly move the tool to the upward side of the tools. When you

ensure that the status is “READY”, please press the key  to enter the 2nd mode status and

then press the key  for two times continuously to start to do the probe. If the configuration item sets the coordinate of tools and selects the “probe of the fixed position”, it doesn't need to move the tools to the upward side of the tools. When you ensure that the

status is “READY”, please press the key  to enter the 2nd mode status and then press the

key  for two times continuously at any position to start to do the probe.

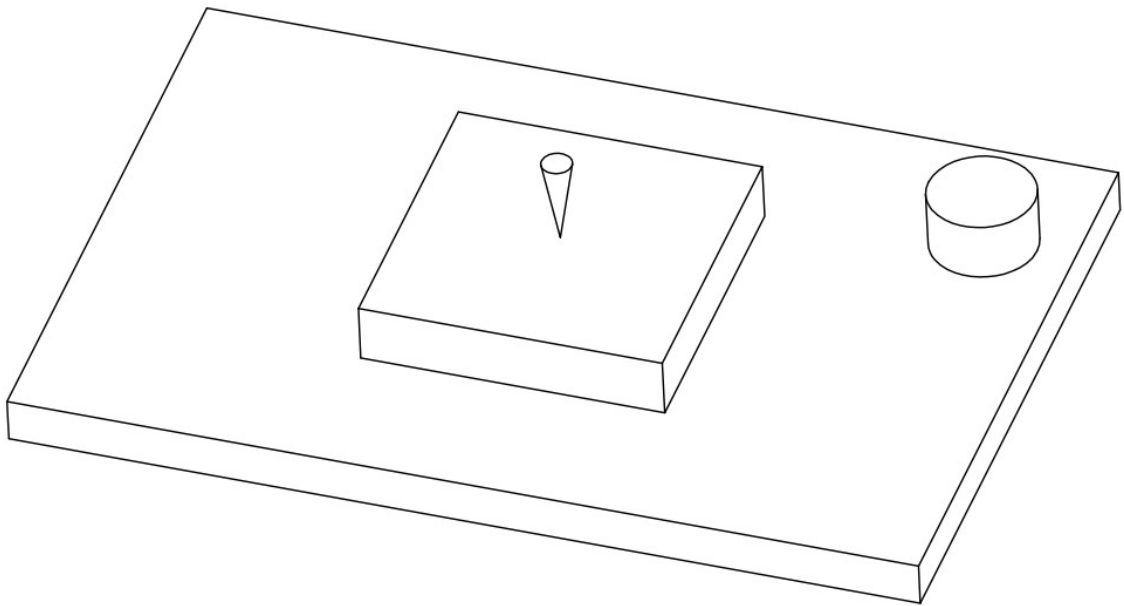

Picture3-63. The tool nose moves to the home of the work piece

Please look at the picture 3-64 about the software interface of probe for reference and look at the picture 3-65 about the schematic diagram of probe.

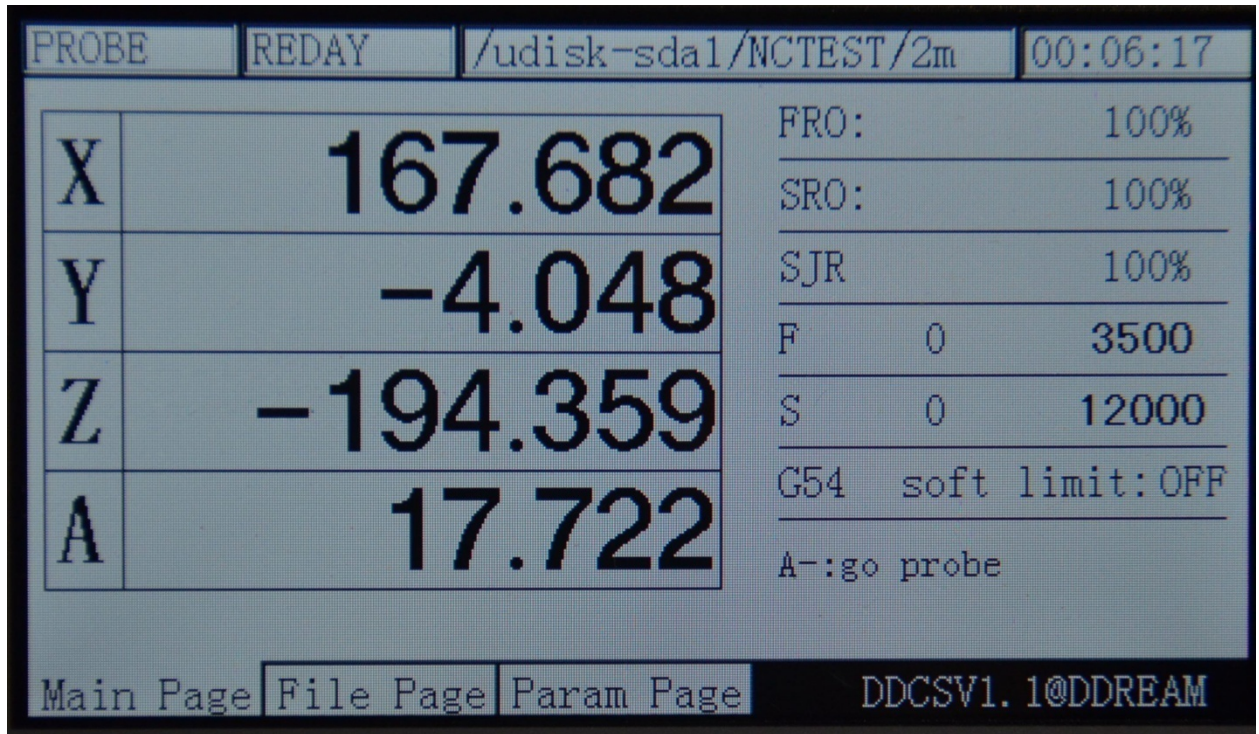

Picture3-64. Probe process

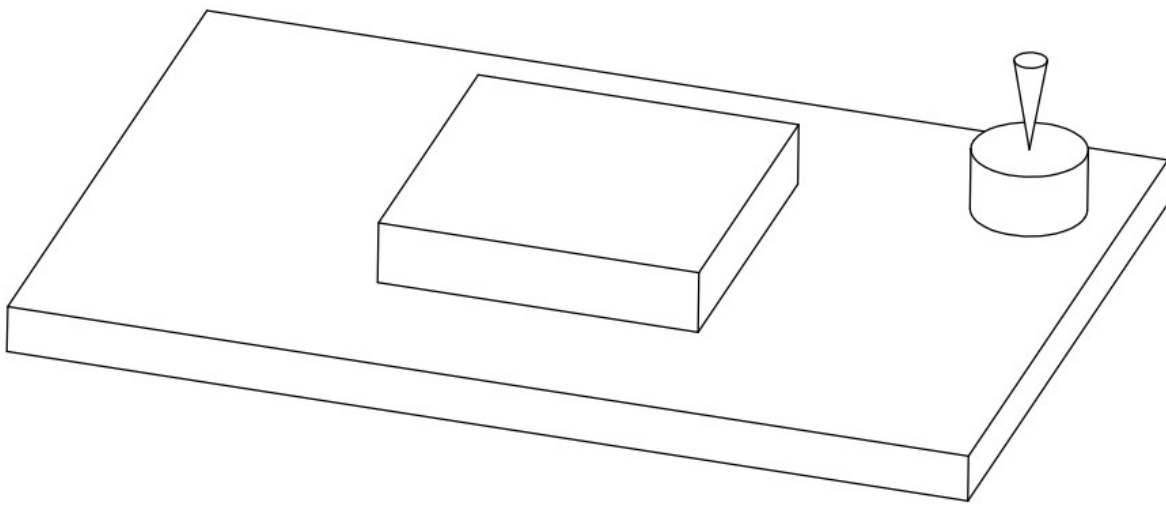

Picture3-65. Begin to probe after the tool nose moves to the upward side of the tool

d. When the first probe is end, the system will automatically save the thickness of virtual probe. The thickness value is height difference from the 0-point of the Z axis work piece to the surface of the tools. When the probe is end, the users can start to load the G code, thus beginning to the actual processing.

e. Probe once again (amend the deviation of the tools), After the tool is in abrasion or the tool is changed, it needs to do the probe again. Please repeat the C action to do the probe again.

3.4 Parameter setting

DDCSV2.1 can adopt the method of modifying parameter list file to modify the parameter.

This file is a text file with an expanded-name of set. The users can modify all the parameter and all the parameter can be modified in the parameter list. We will provide a demo of set file and the client can only modify the corresponding item in this demo. Pay special attention that each parameter item has the only corresponding parameter mark. This parameter mark can't be modified or deleted.

The DDCSV2.1 can also adopt the method of on-line modification configuration. It only needs to switch to the configuration page to search for the configuration items that are required to modify and modify them.

3.4.1 Parameter loading method

Copy the parameter file to the USB flash disk and insert the equipment into the USB interface. As the Picture3-55 shows, press the key  in the main page to ensure that the

status column can display "REDAY" and then press the key  to switch to the file management page. As the Picture 3-66 shows, select the parameter file Uservar.set and then

press the ensure key  to load the parameter file. It probably needs to wait for 1-5s and the "REDAY" of status column will automatically change into "reset" with flashing, which indicates the parameter loads successfully. As the Picture 3-67 shows, the parameter loading is successful.

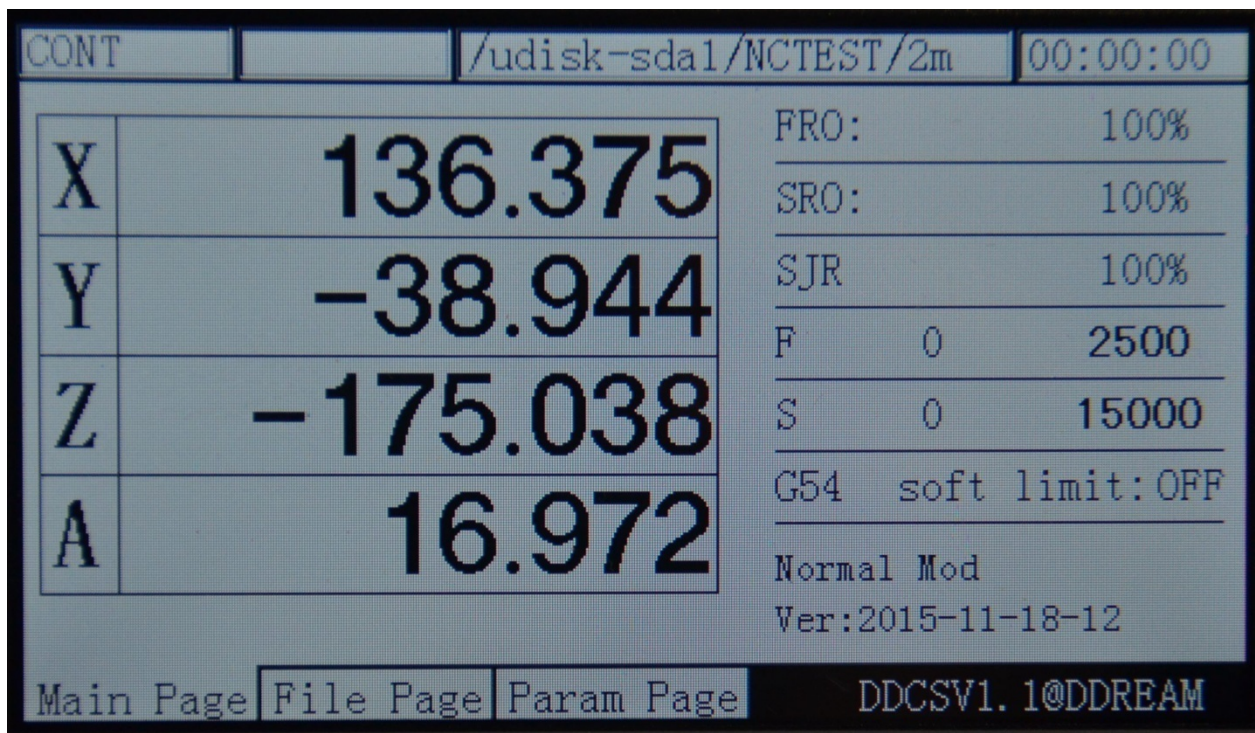

Picture3-66. Ensure the status column is the status of "REDAY"

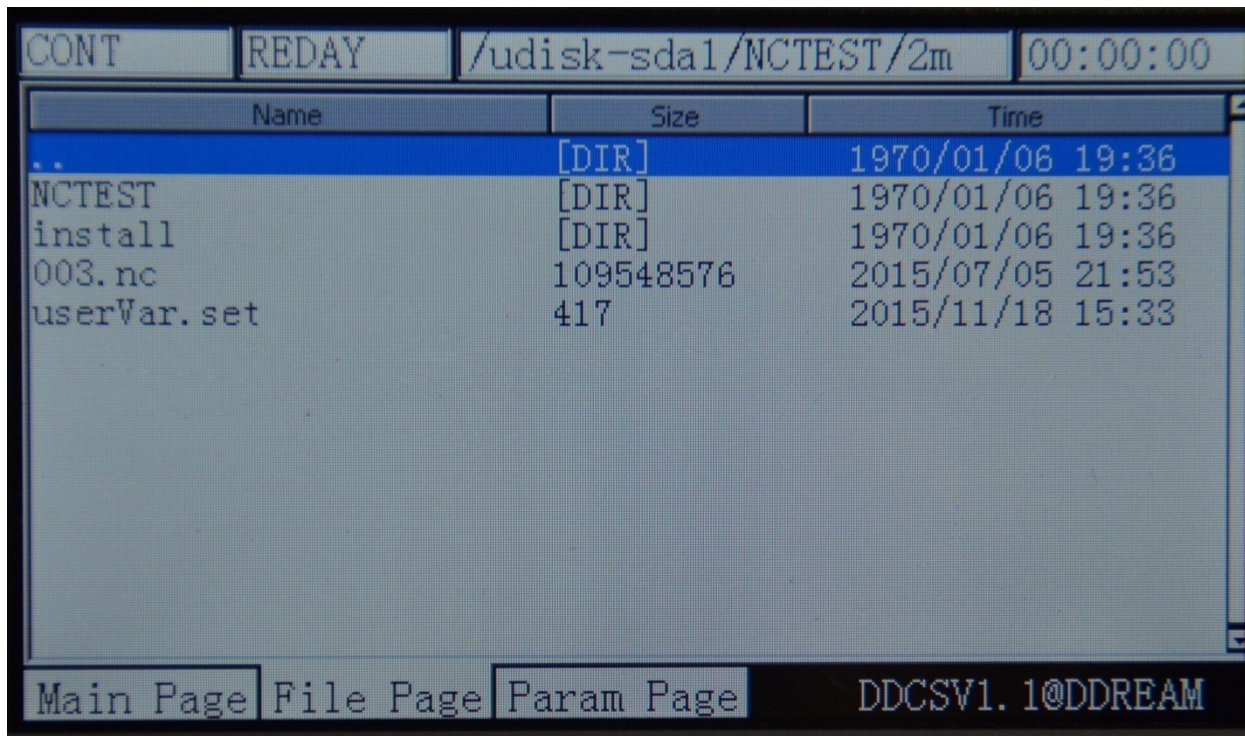



Picture3-67. Select the userVar.set file and press the key

3.4.2 The on-line configuration parameter in the parameter setting page



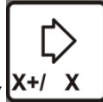

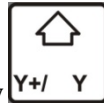
In the main page, ensure the operation status is “REDAY” and press the key  for two times Continuously to enter the parameter configuration page. As the picture 3-68 shows,

in the parameter configuration page, pressing the key  and the key  is to turn

the page forward and backward. Pressing the key  and the key  is to select the current parameter items up and down. When you select the parameters which are required to

modify, please press the key  to enter the current parameter modification mode. At this time, it will pop up a small dialog box of the modified value, which is the same with the other

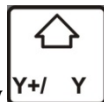
parameters. Pressing the key  and the key  is to adjust the current bit. Pressing

the key  and the key  is to adjust the value of the current bit. After finishing

modification, please press the key  to return to the parameter select. After finishing



modifying the parameter, it needs to press  to return to the homepage, thus loading the parameter and making the parameter takes effect.

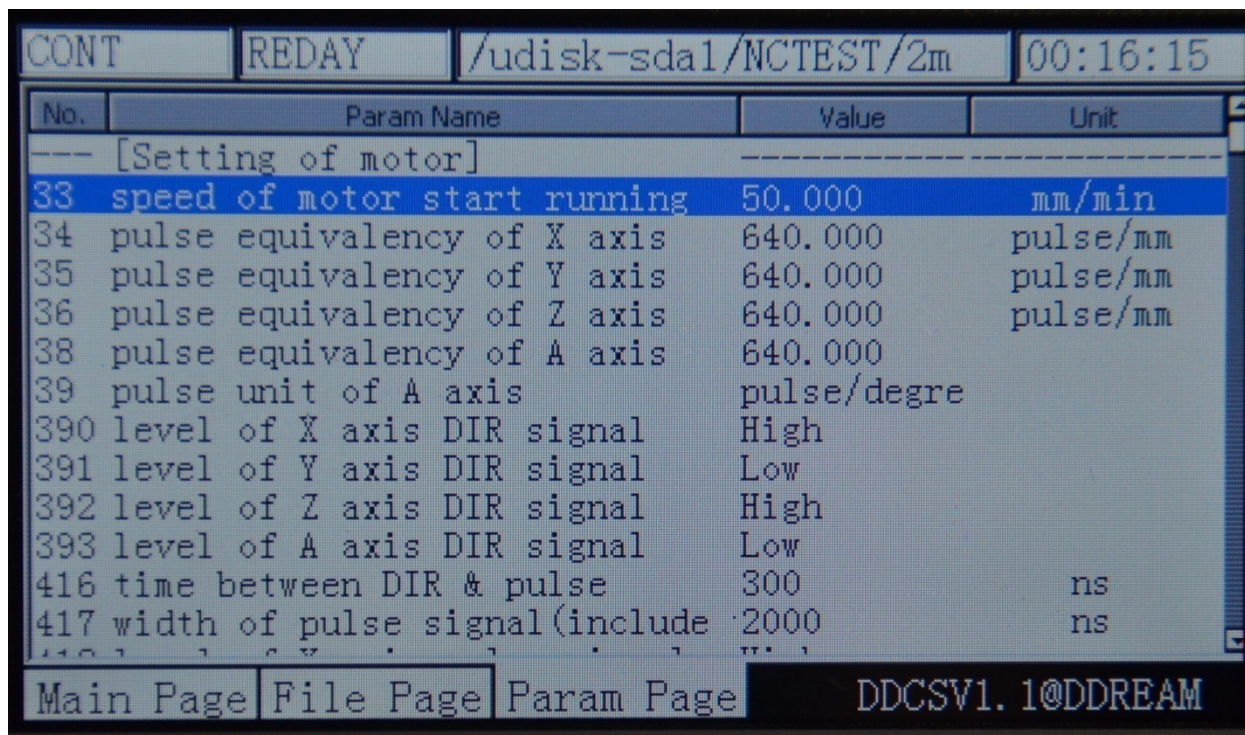

Picture3-68. Enter the parameter configuration page

3.4.3 The detailed definition of parameters

The parameter file can be totally edited, but it needs to follow the definite standards, the standards are as follows:

- a. One line can only be edited one parameter.
- b. The parameter format is #parameter mark= value. Among them, # must be the first character of each line.# should closely be followed by the parameter mar and the following mark is=, and the make= will be followed by the actual value.
- c. After the parameter has assignment and equation, the part of parameter interpretation can have any format without constraint.
- d. Each parameter is regulated with assignment scope. Please do the assignment in strict accordance with the assignment scope.
- e. Each parameter is set with default value in advance. Please use the setting value of default parameter under the situation of not understanding the actual function of this parameter.

1) Configuration parameter of electrical machine(16 in total)

Parameter Mark	Parameter definition	Default value	Parameter Unit	Parameter Scope	Notes
#33	speed of motor start running	50	mm/min	0~200	Speed of motor start running's first step
#34	pulse equivalent of X axis	640	Pulse/mm	100~10000	
#35	pulse equivalent of Y axis	640	Pulse/mm	100~10000	
#36	pulse equivalent of Z axis	640	Pulse/mm	100~10000	

#38	pulse equivalent of A axis	640	Pulse/degree	100~10000	
#39	A axis pulse unit	0	BOOL	1/0	0: Pulse/deg 1: Pulse/circle
#40	AB axis Selection	0	BOOL	1/0	0: A axis 1: B axis
#390	level of X axis DIR signal	0	BOOL	1/0	The value of direction electrical level when the coordinate value of the 4 axis of X,Y,Z,A increases
#391	level of Y axis DIR signal	0	BOOL	1/0	
#392	level of Z axis DIR signal	1	BOOL	1/0	
#393	level of A axis DIR signal	0	BOOL	1/0	
#416	Itime between DIR & pulse	300	ns	0~#417	The direction goes ahead pulse
#418	level of X axis pulse signal	0	BOOL	1/0	axis pulse signal of four axis of X,Y,Z,A as well as the CP signal value when there is no pulse
#419	level of Y axis pulse signal	0	BOOL	1/0	
#420	level of Z axis pulse signal	1	BOOL	1/0	
#421	level of A axis pulse signal	0	BOOL	1/0	

2) Parameter of manual control motion(16 in total)

Parameter mark	Parameter definition	Default value	Parameter unit	Setting scope of parameter	Notes
#41	max speed of X in M_Ctrl mode	16000	mm/min	0~20000	The parameter value of this group has set a upper limit for the SJR
#42	max speed of Y in M_Ctrl mode	16000	mm/min	0~20000	
#43	max speed of Z in M_Ctrl mode	16000	mm/min	0~20000	
#44	max speed of A in M_Ctrl mode	16000	degree/min	0~20000	
#45	start Acceleration of X in M_Ctrl mode	600	mm/s ²	0~2000	4 axis of X,Y,Z,A manual start acceleration
#46	start Acceleration of Y in M_Ctrl mode	600	mm/s ²	0~2000	
#47	start Acceleration of Z in M_Ctrl mode	600	mm/s ²	0~2000	
#48	start Acceleration of A in M_Ctrl mode	600	degree/s ²	0~2000	
#100	manual control speed of X axis	8000	mm/min	0~20000	Panel keys operation the X,Y,Z,A axis Continuously move speed
#101	manual control speed of Y axis	8000	mm/min	0~20000	
#102	manual control speed of Z axis	4000	mm/min	0~20000	
#103	manual control speed of A axis	12000	degree/min	0~20000	
#263	stop Acceleration of X in M_Ctrl mode	1200	mm/s ²	0~2000	4 axis of X,Y,Z,A manually stop acceleration, the stop acceleration can be set appropriately larger
#264	stop Acceleration of Y in M_Ctrl mode	1200	mm/s ²	0~2000	
#265	stop Acceleration of Z in M_Ctrl mode	1200	mm/s ²	0~2000	
#266	stop Acceleration of A in M_Ctrl mode	1200	degree/s ²	0~2000	

3) Automatic processing parameter(11 in total)

Parameter mark	Parameter definition	Default value	Parameter unit	Setting scope of parameter	Notes
#15	select of speed	1	BOOL	1/0	0:set by G code 1 : use default speed
#76	default operation speed	1500	mm/min	0~20000	
#77	maximum speed	8000	mm/min	0~30000	The actual processing speed after the limited FRO under the situation of having the default or setting the speed
#78	protect speed of Z go raise	3000	mm/min	0~20000	Single set a group of speed setting for A axis
#79	protect speed of Z go drop	3000	mm/min	0~20000	
#80	speed of G0	5000	mm/min	0~20000	REDAY travel speed
#82	safe height of Z axis	5	mm	0~500	automatic cutting lift height after ending the processing
#89	z back distance when pause	5	mm	0~99	This value cannot be negative value.
#99	operation acceleration	500	mm/min ²	0~2000	Tangential velocity
#435	protect speed of X axis	8000	mm/min	0~20000	X axial velocity protection
#436	protect speed of Y axis	8000	mm/min	0~20000	Y axial velocity protection

4) Parameter of coordinate system(1 in total)

Parameter mark	Parameter definition	Default value	Unit	Setting scope of parameter	Notes
#16	current coordinate system	1	BOOL	0~6	0~5: G54~G59 6: MACH

5) Parameter of spindle(8 in total)

Parameter mark	Parameter definition	Default value	unit	Parameter scope	Notes
#98	maximum spindle speed	24000	rpm	0~50000	SpindlePWM or voltage signal full range is corresponding to speed value
#220	select of speed	1	BOOL	1/0	0:set by G code 1 : default speed of spindle

#221	default spindle speed	12000	rpm	0~50000	
#222	response of M3/M5	1	BOOL	1/0	1: response 0: not response
#224	response duration of M3/M5	3	S	0~100	Spare enough time to the spindle response
#227	active level of spindle	1	BOOL	1/0	Corresponding output electrical level when the spindle starting
#422	definition of PWM level	0	BOOL	1/0	The output electrical level value of the spindle when the speed is 0 0: 0V,1:10V
#433	rising rate of PWM	1111	Time equivalent	1~65535	The time of rising to full range is #433*0.0005s

6) IO output parameter(5 in total)

Parameter mark	Parameter definition	Default value	Unit	Parameter scope	Notes
#223	response of M code(M8/M9,M10/M11)	1	BOOL	1/0	0: no response 1: response
#225	delay time of M8/M9	1	S	1~20	After appearing M8M9M10M11, it will delay to conduct the next code
#226	delay time of M10/M11	1	S	1~20	
#228	active level of M8/M9	1	BOOL	1/0	Influence the output of M8/M9
#229	active level of M10/M11	1	BOOL	1/0	Influence the output of M10/M11

7) 0-point function parameter(20 in total)

Parameter mark	Parameter definition	Default value	Unit	Parameter scope	Notes
#52	enable of X home function	1	BOOL	1/0	0: not enable 1: enable, this parameter influences the function of Home
#53	enable of Y home function	1	BOOL	1/0	
#54	enable of Z home function	1	BOOL	1/0	
#55	enable of A home function	1	BOOL	1/0	
#56	home speed of X axis	8000	mm/s	1~20000	Single-axis operation speed of Home
#57	home speed of Y axis	8000	mm/s	1~20000	
#58	home speed of Z axis	8000	mm/s	1~20000	
#59	home speed of A axis	8000	mm/s	1~20000	
#60	enable of X home function	0	BOOL	1/0	Active electrical Level signal select of Home
#61	enable of Y home function	0	BOOL	1/0	
#62	enable of Z home function	0	BOOL	1/0	
#63	enable of A home function	0	BOOL	1/0	

#64	direction of X home	0	BOOL	1/0	0:reverse direction home(--) 1:forward direction home(++),
#65	direction of Y home	0	BOOL	1/0	
#66	direction of Z home	0	BOOL	1/0	
#67	direction of A home	0	BOOL	1/0	
#83	back distance of X after home	10	mm	0~1000	After the end of home, each axis needs to leave home switch for a certain distance. The parameter of this group is the back distance setting.
#84	back distance of Y after home	10	mm	0~1000	
#85	back distance of Z after home	10	mm	0~1000	
#86	back distance of A after home	10	mm	0~1000	
#116	Selection of 0 signal source for X axis	0		0/1/2	0:HOME 1:LIMIT++ 2:LIMIT--
#117	Selection of 0 signal source for Y axis	0		0/1/2	
#118	Selection of 0 signal source for Z axis	0		0/1/2	
#119	Selection of 0 signal source for A axis	0		0/1/2	

8) Parameter of probe function(8 in total)

Parameter mark	Parameter definition	Default value	Unit	Parameter scope	Notes
#68	enable of probe	1	BOOL	1/0	0: not enable 1: enable
#69	thickness of tool sensor	20	mm	0~200	
#70	level of probe signal	0	BOOL	1/0	Probe signal inputs the active electrical level
#71	initial tool's position	0	BOOL	1/0	0: current position 1: fixed position
#72	initial X axis in fixed mod	0	mm	0-9999	Tools position X coordinate under the machinery coordinate system
#73	initial Y axis in fixed mod	0	mm	0-9999	Tools position Y coordinate under the machinery coordinate system
#74	initial Z axis in fixed mod	0	mm	0-9999	Height of Z axis before the XY translation under the machinery coordinate system
#75	back distance after probe	10	mm	0~200	Backspacing distance of leaving away the tools

9) Parameter of hard limit function(16 in total)

Parameter mark	Parameter definition	Default value	Unit	Parameter Scope	Notes
#400	enable of X-- limit	1	BOOL	1/0	0: not enable 1: enable
#401	enable of Y-- limit	1	BOOL	1/0	0: not enable 1: enable
#402	enable of Z-- limit	1	BOOL	1/0	0: not enable 1: enable
#403	enable of A-- limit	1	BOOL	1/0	0: not enable 1: enable
#404	enable of X++ limit	1	BOOL	1/0	0: not enable 1: enable
#405	enable of Y++ limit	1	BOOL	1/0	0: not enable 1: enable
#406	enable of Z++ limit	1	BOOL	1/0	0: not enable 1: enable
#407	enable of A++ limit	1	BOOL	1/0	0: not enable 1: enable
#408	active level of X-- limit	0	BOOL	1/0	1: high 0: low
#409	active level of Y-- limit	0	BOOL	1/0	1: high 0: low
#410	active level of Z-- limit	0	BOOL	1/0	1: high 0: low
#411	active level of A-- limit	0	BOOL	1/0	1: high 0: low
#412	active level of X++ limit	0	BOOL	1/0	1: high 0: low
#413	active level of Y++ limit	0	BOOL	1/0	1: high 0: low
#414	active level of Z++ limit	0	BOOL	1/0	1: high 0: low
#415	active level of A++ limit	0	BOOL	1/0	1: high 0: low

10) Parameter of soft limit function (9 in total)

Parameter mark	Parameter definition	Default value	Unit	Parameter scope	Notes
#374	enable of software limit	0	BOOL	1/0	0: not enable 1: enable
#375	value of X-- software limit	-400	BOOL	-2000~0	If the negative exceeds the setting value, it will trigger the limit signal. The limit values all refer to the machinery coordinate, not the work piece coordinate.
#376	value of Y-- software limit	-400	BOOL	-2000~0	
#377	value of Z-- software limit	-400	BOOL	-2000~0	
#378	value of A-- software limit	-400	BOOL	-2000~0	
#379	value of X++ software limit	400	BOOL	0~2000	If the positive exceeds the setting value, it will trigger the limit signal. The limit values all refer to the machinery coordinate, not the work piece coordinate.
#380	value of Y++ software limit	400	BOOL	0~2000	
#381	value of Z++ software limit	400	BOOL	0~2000	
#382	value of A++ software limit	400	BOOL	0~2000	

11) Parameter of MPG function(5 in total)

Parameter mark	Parameter definition	Default value	Unit	Parameter scope	Notes
#428	enable of RESET signal in MPG	1	BOOL	1/0	0: not enable 1: enable
#429	level of RESET signal in MPG	0	BOOL	1/0	Reset the active electrical level
#430	type of MPG port	1	BOOL	1/0	0:UART MPG,1: standard MPG
#431	pulse of MPG	0	BOOL	1/0	0: 100 steps of each circle 1: 24 steps for each circle
#432	IO signal level of MPG	0	BOOL	1/0	Active electrical level of each control bit

12)Parameter extended function(7 in total)

Parameter mark	Parameter definition	Default value	Unit	Parameter scope	Notes
#423	enable of extended RESET	1	BOOL	1/0	0: not enable 1: enable
#424	level of extended RESET	0	BOOL	1/0	
#425	enable of External key	1	BOOL	1/0	0: not enable 1: enable
#426	level of External key 1	0	BOOL	1/0	0:low level,1:high level
#427	level of External key 2	0	BOOL	1/0	0:low level,1:high level
#446	function of External key 1	0	BOOL	1/0	0:start 1:find center.
#467	function of External key 2	0	BOOL	1/0	0:pause 1: zero

13) Parameter of backlash difference(9 in total)

Parameter mark	Parameter definition	Default value	Unit	Parameter scope	Notes
#437	enable of X axis backlash	0	BOOL	1/0	The axis of XYZ delete return difference switch, when it is valid, it will change to the necessary REDAY back distance of setting return difference each time.
#438	enable of Y axis backlash	0	BOOL	1/0	
#439	enable of Z axis backlash	0	BOOL	1/0	
#440	enable of A axis backlash	0	BOOL	1/0	
#441	distance of X axis backlash	0	mm	0~200	Please set the return difference in accordance with the
#442	distance of Y axis backlash	0	mm	0~200	

	backlash				actual machinery of each axis.
#443	distance of Z axis backlash	0	mm	0~200	
#444	distance of A axis backlash	0	mm	0~200	
#445	speed of backlash	0	mm/min	0~2000	

14)Other parameters(6 in total)

Parameter mark	Parameter definition	Default value	Unit	Parameter scope	Notes
#1	language setting	1	BOOL	1/0	0: English 1: Chinese
#2	interface response speed in process	400		400-10000	Note: As for the general embossing file, the parameter can be set as 400. If it is the tiny segment file, please appropriately adjust the parameter to be larger. Strongly suggest the value is 4000.
#495	circle of interpolation	0.002	s	0.002-0.01	circle of interpolation
#250	enable of draw tool road	1	BOOL	1/0	0:disable 1: enable
#253	mode of draw	0	BOOL	1/0	0:statue mode 1:line mode
#499	user access key	888888	NA	0-999999	
#114	Step support in continuous mod	0	BOOL	1/0	0:Enable 1:Disable
#115	Unit selection	0	BOOL	1/0	0:Metric 1:Imperial
#120	If U disk have partition	0	BOOL	1/0	0:YES 1:NO

Mode of draw tool road:

As for the plane line, such as the PCB engraving or the color plates lettering, please adopt the line pattern. As for the plane embossment, please adopt the statue pattern.

3.5 Software upgrade

3.5.1 Introduction

After issuing the produce, we will conduct the software bug amendment or function upgrading in accordance with the feedback of clients and the test results of ourselves at any

moment. Here, we have designed a set of very convenient methods of software upgrading. Moreover, we have issued the latest software upgrade patch on our official website. Official website: <http://www.ddcnc.com>, You can see the latest upgrade file of this product when entering the download column.

3.5.2 Upgrade method

The software upgrade of product is conducted by the USB flash disk. The upgrade method is as follows:

1) Decompress the upgrade file into the USB flash disk

The upgrade patch downloaded from the website or supplied by the suppliers is as the following picture:

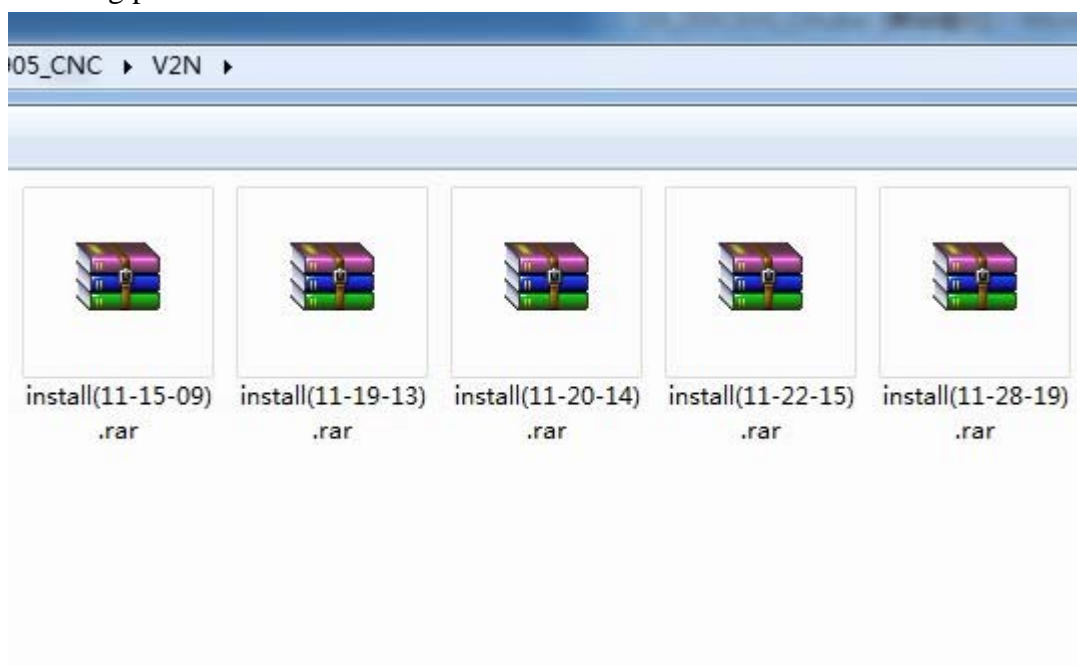

Picture3-69. Software upgrade patch

As the picture shows, the file names of each upgrade patch contain the version number. For example, the version number of first upgrade file is 11-18-12. After finishing upgrading, this version number will appear at the lower right corner of the equipment's interface. Please examine the consistency of the version number after finishing upgrading.see as picture 3-70.

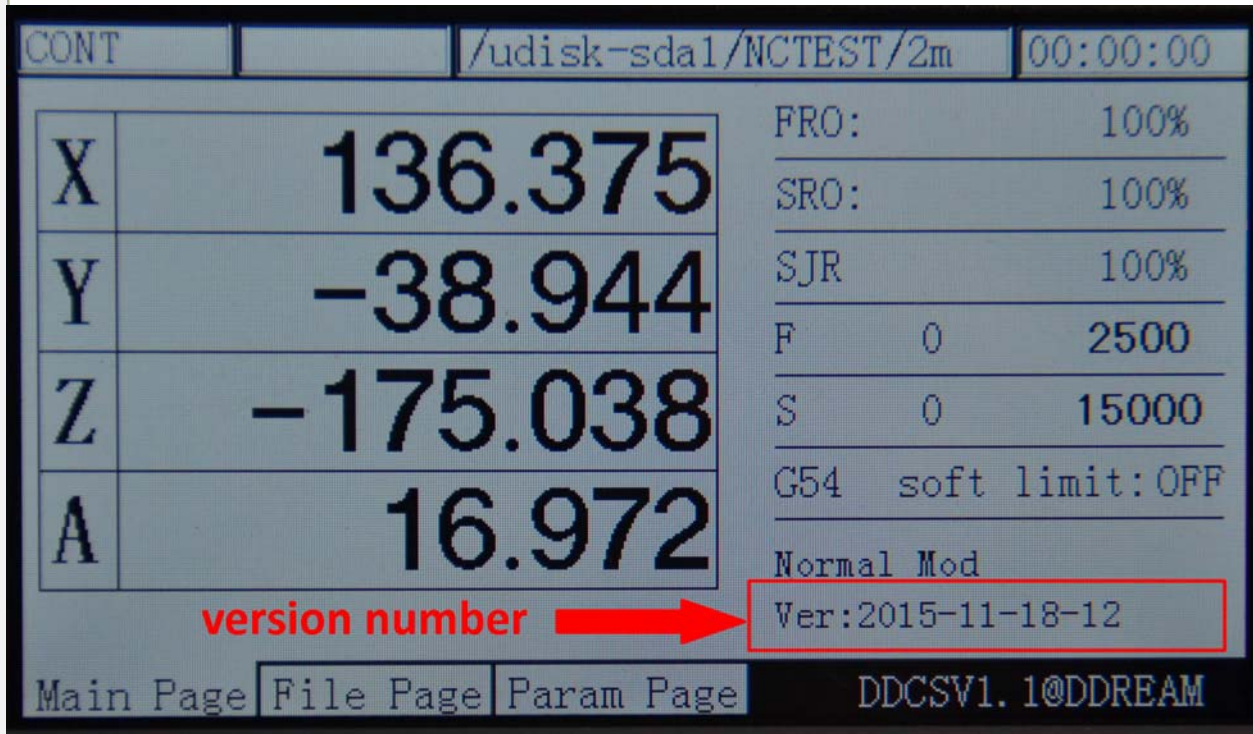

Picture3-70. Position of software version number

It needs to decompress the upgrade file into USB flash disk after downloading the upgrade file. Pay special attentions:decompress the file into the USB's root directory directly. The file after decompressing is as the following picture.

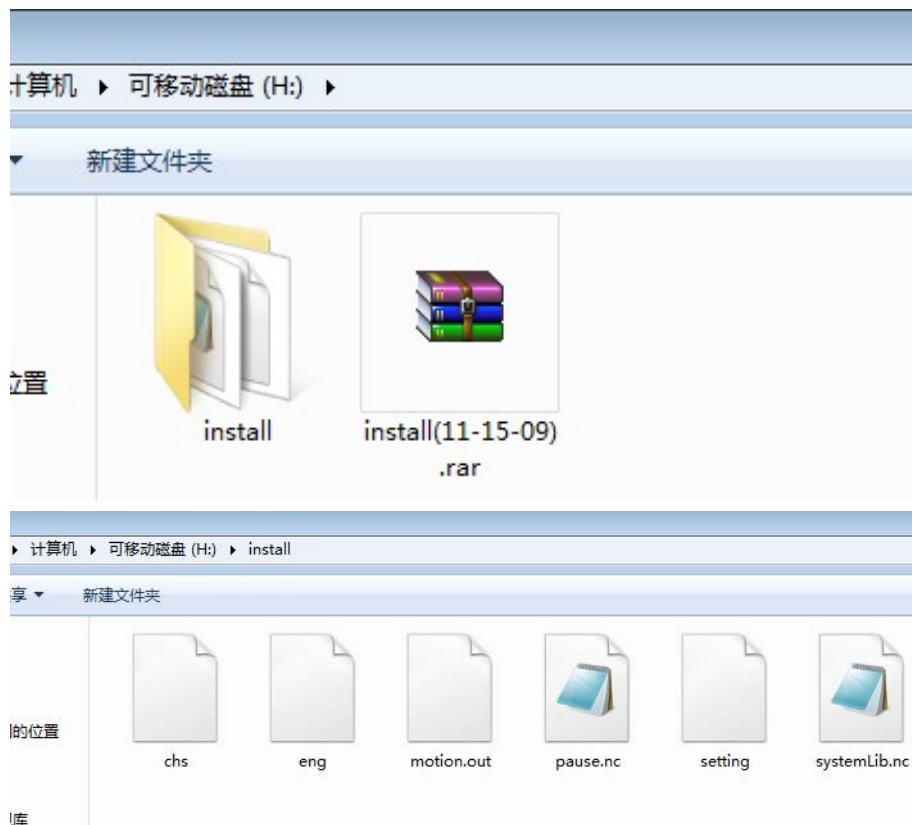

Picture3-71. Upgrade file and its directory

As the picture 3-71 shows, after decompressing the file into the USB's root directory, the file path is X://INSTALL/. There is the upgrade file in this file and the upgrade file totally contains 6 files. Among them, the chs and eng file administrates Chinese field and English field respectively. Motion out is the main program. The pause and systemlib.nc are the extended code files. The setting is the setting file. The upgrade patch that we issued contains such several files. After finishing upgrading, the entire configuration will be in initialization. If the client needs to reserve the configuration items which are set before. Pleasedo the upgrading after deleting the setting file of the upgrading file.

Pay special attention: the upgrade file must be put in the install folder under the USB. Only by this way can the upgrade conduct correctly. If the name of multilevel or the install directory is not correct, all the files cannot be upgraded. The following file path can't be upgraded. See as picture 3-72 and 3-73.

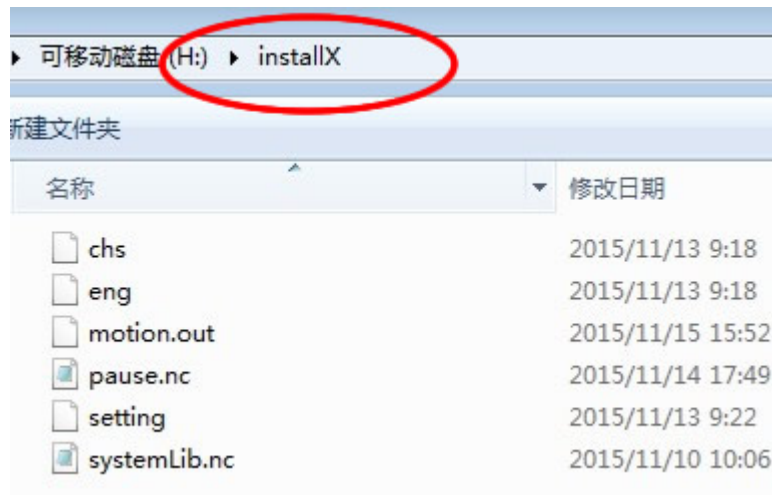

Picture3-72. If the directory name of the upgrade fold under the USB is not install, it can't be upgraded

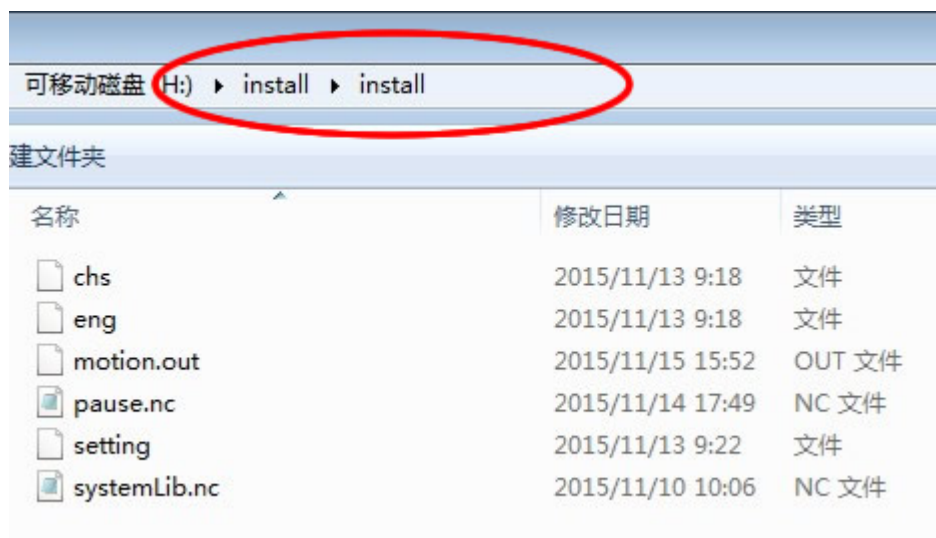

Picture3-73. If there is multilevel install directory, it can be upgraded

1) Begin to upgrade when USB is inserted into the equipment

After the USB has the correct upgrading files, please insert the USB into the equipment and then supply power to the equipment under the situation of no supply power for the equipment. At this time, the service program will automatically upgrade the software of the product. In the process of upgrading, the interface of the equipment will remain in the page of starting up until the complete of the upgrading. It probably needs to wait for 30s. Please wait for it patiently. During the process of upgrading, it can't be outage and you can't do other operations.



Picture 3-72 During the upgrading process, its needs to wait for 30s.

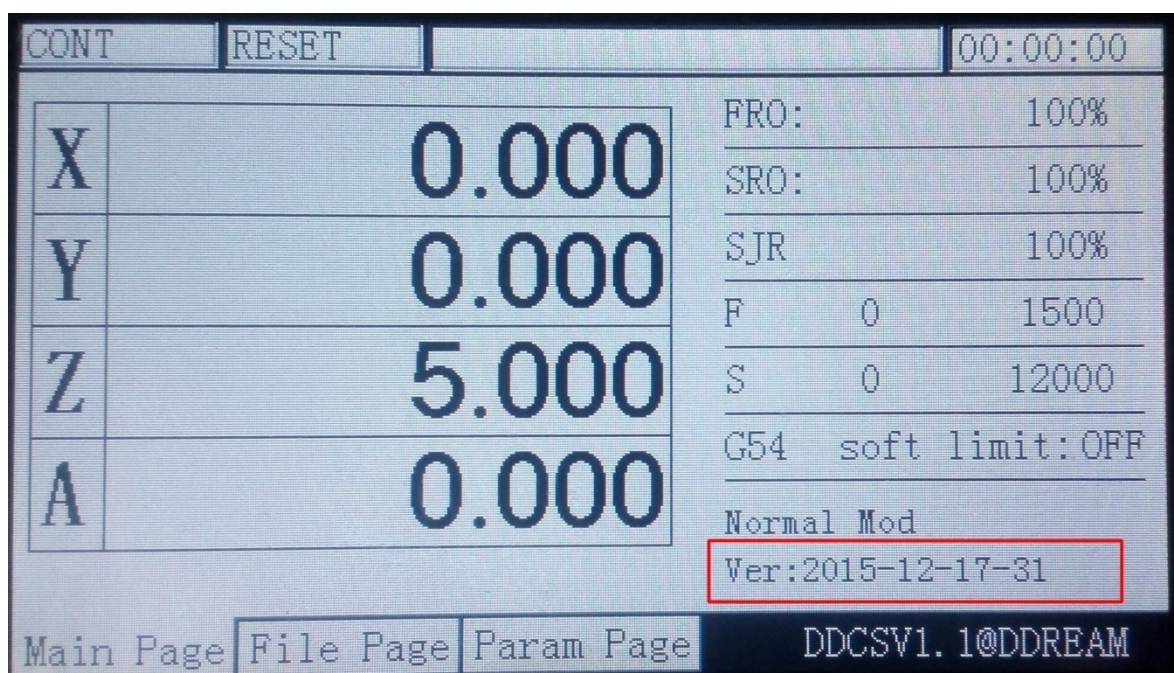

Picture 3-73 after finishing upgrading, it will automatically enter the main page. When you check the software

version number of this product, it is the new version number.

After finishing the upgrading, you can use the new software to start the work.

Chapter Four GCode and M Code

4.1 GCode Set

Code mark	Code name	Code definition	Use case
G0	Quick positioning	Operate to the assigned position with the highest speed set by the system	G0 X..Y.. Z..
G1	Spindle straightaway cut	Operate to the assigned position according to the F value assigned by the system or the file	G1 X..Y.. Z..
G2	Spindle cut along the circle	Arc cutting machining clockwise	Radius method: G2X..Y..Z..R..F.. Circle center method : G2X..Y..Z..I..J..K..F
G3	Spindle cut inverting the circle	Arc cutting machining anticlockwise	Radius method: G2X..Y..Z..R..F.. Circle center method : G2X..Y..Z..I..J..K..F
G17	XY plane select	Interpolation plane selects the XY plane	G17
G18	ZX plane select	Interpolation plane selects the ZX plane	G18
G19	YZ plane select	Interpolation plane selects the YZ plane	G19
G20	British system	Length unit selects the British system	G20
G21	Metric system	Length unit selects the Metric system	G21
G54	G54 coordinate system	Select G54 work piece coordinate system	G54
G55	G55 coordinate system	Select G55 work piece coordinate system	G55
G56	G56 coordinate system	Select G56 work piece coordinate system	G56
G57	G57 coordinate system	Select G57 work piece coordinate system	G57
G58	G58 coordinate system	Select G58 work piece coordinate system	G58
G59	G59 coordinate system	Select G59 work piece coordinate system	G59
G81	Drill hole code		G81 X..Y..Z..R..F..
G82	Drill hole code		G82 X..Y..Z..R..P..F..
G83	Circulation Drill		G83 X..Y..Z..R..I..F..

	hole code		
G90	Absolute size		G90X..Y..
G91	Increment size		G91X..Y..
G98	Back to R point	Back to R point according to the time feed fixed circulation	
G99	Fixed circulation	Used with the coordination of G81/G82/G83	

Note: ..represents the actual users setting value.

4.2 M Code Set

Code mark	Code name	Code definition	Use case
M3	Spindle rotates forward	The set of output control signal for spindle rotates forward is valid	M3
M5	Spindle stop	The set of output control signal for spindle rotates forward is invalid	M5
M8	Start of water-cooling	The set of water-cooling output control signal is valid	M8
M9	Stop of water-cooling	The set of water-cooling output control signal is invalid	M9
M10	Start of lubricating oil	The set of lubricating oil output control is valid	M10
M11	Close of the lubricating oil	The set of lubricating oil output control is invalid	M11

Chapter Five Contact and Feedback

5.1 Question and answer

1、 After the operation of goto zero, what's the specific action of the mechanical part?

Answer: The goto zero strategy is: if the current position of Z axis is lower than the safety height, please firstly lift the Z to a safety height and then XYA goto zero; If the current position of Z axis is higher than the safety height, please firstly XYA gotoz, and then shift Z to the safety height.

2、 The pause action in the processing process

Answer: When processing start or pause start, it will feeds to the pause action: Firstly, lift the Z axis to the safety height (safez.nc conducts the custom made, if this file is empty, it can't be lifted) and then judge the current Z position of tool nose and the Z position of tool nose. If the current position is higher than the thread residue Z coordinate, please firstly shift the xy, and then shift the Z. If the current position is lower than the thread residue Z coordinate, please firstly lift the tool to the position of thread residue Z coordinate, and then shift the xy. For example:

a. For instance, the start point of a segment is (0,0,0), and the terminal point is (100,100,100) . If pause in the middle position (50,50,50) , it will be the recovery action. (suppose the safety height doesn't work), please firstly shift the XY to the (0,0) , and then decline the Z to 0.

b. For instance, the start point of a segment is (0,0,0), and the terminal point is (-100,-100,-100), If I pause in the middle position (-50,-50,-50) it will be the recovery action. (Suppose the safety height doesn't work), please firstly lift the Z to 0, and then shift the XY to (0, 0) .

3、 What's the action of the M30 code?

M30 action: turn off the spindle, cooling, and lubrication and then make the Z axis back to the safety height and then XYA goto zero. This action will be custom-made in the m30.nc. If this file is empty, it cannot conduct any movement action (the off of spindle, cooling and lubrication are not affected).

4、 What's the action of lifting tool when it pauses?

Answer: the action of lifting tool when it Pauses: when it pauses, the Z axis will be tool retracting in accordance with the #89 parameter (when it pauses, the tool retracting distance of Z axis). If the value is 0, it will not be tool retracting.

5、 What's the action of pause and recovery processing?

Answer: When it pauses, it will start to speed down at the pause point until it stops. The recovery processing action will firstly shift to the start point of the pause code segment and

then start processing. For example, if the length of the segment is 100mm, it will pause at the position of 50mm. After the recovery of pause, the tool will shift to the head of the segment to conduct the processing again.